



Soluções Inteligentes em
Vigilância e Segurança Patrimonial

F. M. D.

ASSEMBLÉIA LEGISLATIVA DO ESTADO DE SERGIPE
PROPOSTA DE PREÇOS
PROPOSTA

75 9 9958-1806
71 9 9228-1671

comercial@reisseguranca.com.br
www.reisseguranca.com.br

Tv. Eva Todor, nº 27, Bairro: Juracy Magalhães
Alagoinhas/Ba - CEP: 48005-254

[Handwritten signatures and initials]



PREGÃO ELETRÔNICO Nº 01/2023		DATA DE ABERTURA: 01/02/2024	
NOME DA EMPRESA: REI SEGURANÇA PATRIMONIAL LTDA			
CNPJ FILIAL: 22.102.789/0002-05			
INSCRIÇÃO MUNICIPAL: 144253-1			
ENDEREÇO FILIAL: Rua Aloísio Campos, nº 1320, Bairro: Coroa do Meio - CEP: 49.035-131 - Aracaju - Sergipe			
TELEFONE: (79) 99901-2897			
E-MAIL: comercial@reiseguranca.com.br			
NOME DO REPRESENTANTE LEGAL DA EMPRESA: Reginaldo Barreto Silva			
CPF: 716.379.235-20		RG: 533711193	

OBJETO: Contratação de empresa especializada na prestação de serviços de segurança integrada, composto de vigilância ostensiva com um quantitativo de 72 (setenta e dois) homens e sistema de vigilância eletrônica com monitoramento remoto CFTV, composto por 90 (noventa) câmeras, conforme especificações contidas no Edital, além de uma sala de monitoramento composta por uma estação de visualização com vídeo wall, com 4 TVs full HD e uma estação de visualização simples para operação do sistema de CFTV, conforme especificações contidas no Edital. Os serviços serão prestados nas dependências e Anexos Administrativos deste Poder Legislativo.

ITEM	DESCRIÇÃO DO SERVIÇO	QUANT.	UNID.	VALOR UNITÁRIO POR POSTO	VALOR MENSAL POR POSTO	VALOR ANUAL POR POSTO
1.1	VIGILÂNCIA E SEGURANÇA PATRIMONIAL. Sistema de vigilância ostensiva formada por postos. Posto diurno/Armado.	23	POSTO	R\$ 11.187,12	R\$ 257.303,66	R\$ 3.087.643,88
1.2	VIGILÂNCIA E SEGURANÇA PATRIMONIAL. Sistema de vigilância ostensiva formada por postos. Posto Noturno/Armado	13	POSTO	R\$ 13.589,66	R\$ 176.665,58	R\$ 2.119.986,96
1.3	VIGILÂNCIA E SEGURANÇA PATRIMONIAL. Agente de Segurança Pessoal Privada - ASPP	20	HÓRAS/MÊS	R\$ 53,31	R\$ 1.066,20	R\$ 12.794,40
1.4	SISTEMA DE VIGILÂNCIA ELETRÔNICA com monitoramento remoto CFTV, composto por 90 (noventa) conjuntos de equipamentos.	90	UNID.	R\$ 419,28	R\$ 37.735,20	R\$ 452.822,40
VALOR TOTAL MENSAL						R\$ 472.770,64
(Quatrocentos e setenta e dois Mil, setecentos e setenta Reais e sessenta e quatro centavos)						
VALOR TOTAL GLOBAL						R\$ 5.673.247,64
(Cinco Milhões, seiscentos e setenta e três Mil, duzentos e quarenta e sete Reais e sessenta e quatro centavos)						

VALIDADE DA PROPOSTA: 60 (SESSENTA) DIAS

SINDICATO DA CATEGORIA PROFISSIONAL: SINDICATO DOS EMPREGADOS EM EMPRESAS DE SEGURANCA,VIGILANCIA TRANSPORTE DE VALORES,ELETRONICA E SIMILARES DO ESTADO DE SERGIPE - SINDIVIGILANTE/SE

Aracaju-SF, 01 de Fevereiro de 2023

Documento assinado digitalmente

g .b REGINALDO BARRETO SILVA
Data: 31/01/2024 19:03:06-0300
Verifique em <https://validar.iti.gov.br>

REI SEGURANÇA PATRIMONIAL LTDA
Reginaldo Barreto Silva
Diretor



PLANILHA DE CUSTOS 1 - POSTO DIURNO

PLANILHA DE PREÇOS DE VIGILÂNCIA ARMADA - POSTO 12x36 DIURNO

CATEGORIA:	Vigilante Diurno
QUANTIDADE DE VIGILANTES:	2
SALÁRIO BASE:	R\$ 1.484,28

MONTANTE A

I. MÃO DE OBRA (VIGILANTE POR POSTO)	PERCENTUAL	VALOR DA PROPOSTA
01 - SALÁRIO	100,00%	R\$ 2.968,56
02 - RISCO DE VIDA (PERICULOSIDADE)	30,00%	R\$ 890,57
03 - ADICIONAL NOTURNO		
04 - HORA NOTURNA REDUZIDA		
05 - DSR SOBRE ADICIONAL NOTURNO		
06 - DSR SOBRE ADIC. H. NOTURNA REDUZIDA		
07 - TOTAL DA REMUNERAÇÃO		R\$ 3.859,13
08 - RESERVA TÉCNICA		
09 - TOTAL (Remuneração + Reserva Técnica)		R\$ 3.859,13

II - ENCARGOS SOCIAIS:

GRUPO "A"			
01 - INSS	20,00%	R\$	771,83
02 - FGTS	8,00%	R\$	308,73
03 - SAT (RAT = 3,00 X FAP = 1,87)	5,61%	R\$	216,50
04 - SALÁRIO EDUCAÇÃO	2,50%	R\$	96,48
05 - SESC/SESI	1,50%	R\$	57,89
06 - SENAC/SENAI	1,00%	R\$	38,59
07 - SEBRAE	0,60%	R\$	23,15
08 - INCRA	0,20%	R\$	7,72
TOTAL DO GRUPO "A"	39,41%	R\$	1.520,88

GRUPO "B"

10 - FÉRIAS	8,33%	R\$	321,47
11 - AUXÍLIO DOENÇA	2,10%	R\$	81,04
12 - ACIDENTE DE TRABALHO	1,33%	R\$	51,33
13 - AUXÍLIO MATERNIDADE/PATERNIDADE	0,15%	R\$	5,79
14 - FALTAS LEGAIS	0,18%	R\$	6,95
15 - RECICLAGEM	0,03%	R\$	1,16
16 - AVISO PRÉVIO TRABALHADO	1,94%	R\$	74,87
17 - REPRESENTAÇÃO SINDICAL	0,02%	R\$	0,77
18 - 1/3 FÉRIAS	2,78%	R\$	107,28
19 - 13º SALÁRIO	8,33%	R\$	321,47
TOTAL DO GRUPO "B"	25,19%	R\$	972,11

GRUPO "C"

20 - AVISO PRÉVIO INDENIZADO	3,66%	R\$	141,24
21 - FGTS S/ AVISO PRÉVIO	0,29%	R\$	11,30
22 - CONTRIBUIÇÃO SOCIAL S/ AVISO PRÉVIO	0,37%	R\$	14,12
23 - REFLEXOS NO AVISO PRÉVIO INDENIZADO	0,01%	R\$	0,39
24 - MULTA DO FGTS	3,20%	R\$	123,49
25 - CONTRIBUIÇÃO SOCIAL	0,80%	R\$	30,87
26 - INDENIZAÇÃO ADICIONAL	1,14%	R\$	43,99
TOTAL DO GRUPO "C"	9,47%	R\$	365,41

GRUPO "D"

27 - INCIDENCIA DOS ENCARGOS DO GRUPO "A" SOBRE OS ITENS DO GRUPO "B"	9,93%	R\$	383,11
TOTAL DO GRUPO "D"	9,93%	R\$	383,11
TOTAL DOS ENCARGOS SOCIAIS	84,00%	R\$	3.241,51

VALOR TOTAL DA MÃO DE OBRA	R\$	7.100,64
-----------------------------------	------------	-----------------

REI SEGURANÇA PATRIMONIAL LTDA

CNPJ Nº 22.102.789/0002-05

Rua Aloísio Campos, nº 1320, Bairro: Coroa do Meio - CEP: 49.035-131 - Aracaju - Sergipe

comercial@reisseguranca.com.br



MONTANTE B			
II - INSUMOS			
01 - PSICOTÉCNICO		R\$	46,00
02 - EXAME PERIÓDICO ADMISIONAL		R\$	46,00
03 - UNIFORMES/EPIS		R\$	96,00
04 - EQUIPAMENTOS		R\$	125,00
05 - VALE TRANSPORTE		R\$	91,89
06 - VALE ALIMENTAÇÃO		R\$	590,76
07 - TREINAMENTO E/OU RECICLAGEM DE PESSOAL		R\$	110,00
08 - SEGURO DE VIDA EM GRUPO		R\$	8,00
09 - PRÊMIO DE ASSIDUIDADE			
10 - COMPENSAÇÃO INTERVALO INTRAJORNADA		R\$	394,80
11 - COTA DE APRENDIZAGEM (CLAU. 5ª, §12 DO ITA DA CCT 2023)		R\$	118,90
12 - CAIXA DE ASSISTENCIAL		R\$	120,00
SOMA DOS INSUMOS		R\$	1.747,35
13 - RESERVA TÉCNICA			
TOTAL DOS INSUMOS		R\$	1.747,35
TOTAL MÃO DE OBRA + INSUMOS		R\$	8.847,99
IV - DEMAIS COMPONENTES			
01 - DESPESAS ADMINISTRATIVAS/OPERACIONAIS	10,00%	R\$	884,80
02 - LUCRO	5,00%	R\$	486,64
SOMA DOS INSUMOS	15,00%	R\$	1.371,44
TOTAL GERAL ANTES DOS TRIBUTOS		R\$	10.219,43
V. APURAÇÃO DO VALOR GLOBAL MENSAL:			
TOTAL GERAL ANTES DOS TRIBUTOS		R\$	10.219,43
TRIBUTOS INCIDENTES SOBRE VALOR GLOBAL			
01 - COFINS	3,00%	R\$	335,61
02 - PIS	0,65%	R\$	72,72
03 - ISS	5,00%	R\$	559,36
TOTAL DOS TRIBUTOS	8,65%	R\$	967,69
VALOR MENSAL DO POSTO		R\$	11.187,12

Aracaju-SE, 01 de Fevereiro de 2024

g vb

Documento assinado digitalmente
REGINALDO BARRETO SILVA
Data: 31/01/2024 18:25:54-0300
Verifique em <https://validar.itl.gov.br>

REI SEGURANÇA PATRIMONIAL LTDA
CNPJ: 22.102.789/0002-05
Reginaldo Barreto Silva
CPF: 716.379.235-20
Diretor



PLANILHA DE CUSTOS 1 - POSTO DIURNO

PLANILHA DE PREÇOS DE VIGILÂNCIA ARMADA - POSTO 12x36 NOTURNO

CATEGORIA:	Vigilante Noturno
QUANTIDADE DE VIGILANTES:	2
SALÁRIO BASE:	R\$ 1.484,28

MONTANTE A

I. MÃO DE OBRA (VIGILANTE POR POSTO)	PERCENTUAL	VALOR DA PROPOSTA
01 - SALÁRIO	100,00%	R\$ 2.968,56
02 - RISCO DE VIDA (PERICULOSIDADE)	30,00%	R\$ 890,57
03 - ADICIONAL NOTURNO	20,00%	R\$ 367,50
04 - HORA NOTURNA REDUZIDA		R\$ 432,30
05 - DSR SOBRE ADICIONAL NOTURNO		R\$ 73,50
06 - DSR SOBRE ADIC. H. NOTURNA REDUZIDA		R\$ 86,46
07 - TOTAL DA REMUNERAÇÃO		R\$ 4.818,89
08 - RESERVA TÉCNICA		
09 - TOTAL (Remuneração + Reserva Técnica)		R\$ 4.818,89

II - ENCARGOS SOCIAIS:

GRUPO "A"			
01 - INSS	20,00%	R\$	963,78
02 - FGTS	8,00%	R\$	385,51
03 - SAT (RAT = 3,00 X FAP = 1,87)	5,61%	R\$	270,34
04 - SALÁRIO EDUCAÇÃO	2,50%	R\$	120,47
05 - SESC/SESI	1,50%	R\$	72,28
06 - SENAC/SENAI	1,00%	R\$	48,19
07 - SEBRAE	0,60%	R\$	28,91
08 - INCRA	0,20%	R\$	9,64
TOTAL DO GRUPO "A"	39,41%	R\$	1.899,12

GRUPO "B"

10 - FÉRIAS	8,33%	R\$	401,41
11 - AUXÍLIO DOENÇA	2,10%	R\$	101,20
12 - ACIDENTE DE TRABALHO	1,33%	R\$	64,09
13 - AUXÍLIO MATERNIDADE/PATERNIDADE	0,15%	R\$	7,23
14 - FALTAS LEGAIS	0,18%	R\$	8,67
15 - RECICLAGEM	0,03%	R\$	1,45
16 - AVISO PRÉVIO TRABALHADO	1,94%	R\$	93,49
17 - REPRESENTAÇÃO SINDICAL	0,02%	R\$	0,96
18 - 1/3 FÉRIAS	2,78%	R\$	133,97
19 - 13º SALÁRIO	8,33%	R\$	401,41
TOTAL DO GRUPO "B"	25,19%	R\$	1.213,88

GRUPO "C"

20 - AVISO PRÉVIO INDENIZADO	3,66%	R\$	176,37
21 - FGTS S/ AVISO PRÉVIO	0,29%	R\$	14,11
22 - CONTRIBUIÇÃO SOCIAL S/ AVISO PRÉVIO	0,37%	R\$	17,64
23 - REFLEXOS NO AVISO PRÉVIO INDENIZADO	0,01%	R\$	0,48
24 - MULTA DO FGTS	3,20%	R\$	154,20
25 - CONTRIBUIÇÃO SOCIAL	0,80%	R\$	38,55
26 - INDENIZAÇÃO ADICIONAL	1,14%	R\$	54,94
TOTAL DO GRUPO "C"	9,47%	R\$	456,29

GRUPO "D"

27 - INCIDENCIA DOS ENCARGOS DO GRUPO "A" SOBRE OS ITENS DO GRUPO "B"	9,93%	R\$	478,39
TOTAL DO GRUPO "D"	9,93%	R\$	478,39
TOTAL DOS ENCARGOS SOCIAIS	84,00%	R\$	4.047,68

VALOR TOTAL DA MÃO DE OBRA	R\$	8.866,57
-----------------------------------	------------	-----------------

[Handwritten signatures and initials]



MONTANTE B		
II - INSUMOS		
01 - PSICOTÉCNICO	R\$	46,00
02 - EXAME PERIÓDICO ADMISIONAL	R\$	46,00
03 - UNIFORMES/EPIS	R\$	96,00
04 - EQUIPAMENTOS	R\$	125,00
05 - VALE TRANSPORTE	R\$	91,89
06 - VALE ALIMENTAÇÃO	R\$	590,76
07 - TREINAMENTO E/OU RECICLAGEM DE PESSOAL	R\$	110,00
08 - SEGURO DE VIDA EM GRUPO	R\$	8,00
09 - PRÊMIO DE ASSIDUIDADE	R\$	96,76
10 - COMPENSAÇÃO INTERVALO INTRAJORNADA	R\$	432,30
11 - COTA DE APRENDIZAGEM (CLAU, 5º, §12 DO ITA DA CCT 2023)	R\$	118,90
12 - CAIXA DE ASSISTENCIAL	R\$	120,00
SOMA DOS INSUMOS	R\$	1.881,61
13 - RESERVA TÉCNICA		
TOTAL DOS INSUMOS	R\$	1.881,61

TOTAL MÃO DE OBRA + INSUMOS	R\$	10.748,18
------------------------------------	------------	------------------

IV - DEMAIS COMPONENTES			
01 - DESPESAS ADMINISTRATIVAS/OPERACIONAIS	10,00%	R\$	1.074,82
02 - LUCRO	5,00%	R\$	591,15
SOMA DOS INSUMOS	15,00%	R\$	1.665,97

TOTAL GERAL ANTES DOS TRIBUTOS	R\$	12.414,15
---------------------------------------	------------	------------------

V. APURAÇÃO DO VALOR GLOBAL MENSAL:	
TOTAL GERAL ANTES DOS TRIBUTOS	R\$ 12.414,15

TRIBUTOS INCIDENTES SOBRE VALOR GLOBAL			
01 - COFINS	3,00%	R\$	407,69
02 - PIS	0,65%	R\$	88,33
03 - ISS	5,00%	R\$	679,48
TOTAL DOS TRIBUTOS	8,65%	R\$	1.175,51
VALOR MENSAL DO POSTO		R\$	13.589,66

Aracaju-SE, 01 de Fevereiro de 2024

Documento assinado digitalmente
g vb REGINALDO BARRETO SILVA
Data: 31/01/2024 18:25:54-0300
Verifique em <https://validar.iti.gov.br>

REI SEGURANÇA PATRIMONIAL LTDA
CNPJ: 22.102.789/0002-05
Reginaldo Barreto Silva
CPF: 716.379.235-20
Diretor

[Handwritten signatures and initials]



PLANILHA DE CUSTOS 1 - POSTO ASSP

PLANILHA DE PREÇOS DE VIGILÂNCIA ARMADA - POSTO 12x36 24 HORAS

CATEGORIA:	ASSP
QUANTIDADE DE VIGILANTES:	4
SALÁRIO BASE:	R\$ 2.456,68

MONTANTE A

I. MÃO DE OBRA (VIGILANTE POR POSTO)	PERCENTUAL	VALOR DA PROPOSTA
01 - SALÁRIO	100,00%	R\$ 9.826,72
02 - RISCO DE VIDA (PERICULOSIDADE)	30,00%	R\$ 2.948,02
03 - ADICIONAL NOTURNO	20,00%	R\$ 609,70
04 - HORA NOTURNA REDUZIDA		R\$ 715,48
05 - DSR SOBRE ADICIONAL NOTURNO		R\$ 121,65
06 - DSR SOBRE ADIC. H. NOTURNA REDUZIDA		R\$ 143,10
07 - TOTAL DA REMUNERAÇÃO		R\$ 14.364,67
08 - RESERVA TÉCNICA		
09 - TOTAL (Remuneração + Reserva Técnica)		R\$ 14.364,67

II - ENCARGOS SOCIAIS:

GRUPO "A"			
01 - INSS	20,00%	R\$	2.872,93
02 - FGTS	8,00%	R\$	1.149,17
03 - SAT (RAT = 3,00 X FAP = 1,87)	5,61%	R\$	805,86
04 - SALÁRIO EDUCAÇÃO	2,50%	R\$	359,12
05 - SESC/SESI	1,50%	R\$	215,47
06 - SENAC/SENAI	1,00%	R\$	143,65
07 - SEBRAE	0,60%	R\$	86,19
08 - INCRA	0,20%	R\$	28,73
TOTAL DO GRUPO "A"	39,41%	R\$	5.661,12

GRUPO "B"

10 - FÉRIAS	8,33%	R\$	1.196,58
11 - AUXÍLIO DOENÇA	2,10%	R\$	301,66
12 - ACIDENTE DE TRABALHO	1,33%	R\$	191,05
13 - AUXÍLIO MATERNIDADE/PATERNIDADE	0,15%	R\$	21,55
14 - FALTAS LEGAIS	0,18%	R\$	25,86
15 - RECICLAGEM	0,03%	R\$	4,31
16 - AVISO PRÉVIO TRABALHADO	1,94%	R\$	278,67
17 - REPRESENTAÇÃO SINDICAL	0,02%	R\$	2,87
18 - 1/3 FÉRIAS	2,78%	R\$	399,34
19 - 13º SALÁRIO	8,33%	R\$	1.196,58
TOTAL DO GRUPO "B"	25,19%	R\$	3.618,46

GRUPO "C"

20 - AVISO PRÉVIO INDENIZADO	3,66%	R\$	525,75
21 - FGTS S/ AVISO PRÉVIO	0,29%	R\$	42,06
22 - CONTRIBUIÇÃO SOCIAL S/ AVISO PRÉVIO	0,37%	R\$	52,57
23 - REFLEXOS NO AVISO PRÉVIO INDENIZADO	0,01%	R\$	1,44
24 - MULTA DO FGTS	3,20%	R\$	459,67
25 - CONTRIBUIÇÃO SOCIAL	0,80%	R\$	114,92
26 - INDENIZAÇÃO ADICIONAL	1,14%	R\$	163,76
TOTAL DO GRUPO "C"	9,47%	R\$	1.360,16

GRUPO "D"

27 - INCIDENCIA DOS ENCARGOS DO GRUPO "A" SOBRE OS ITENS DO GRUPO "B"	9,93%	R\$	1.426,04
TOTAL DO GRUPO "D"	9,93%	R\$	1.426,04
TOTAL DOS ENCARGOS SOCIAIS	84,00%	R\$	12.065,78

VALOR TOTAL DA MÃO DE OBRA	R\$	26.430,45
-----------------------------------	------------	------------------



MONTANTE B		
II - INSUMOS		
01 - PSICOTÉCNICO	R\$	92,00
02 - EXAME PERIÓDICO ADMISSIONAL	R\$	92,00
03 - UNIFORMES/EPIS	R\$	192,00
04 - EQUIPAMENTOS	R\$	125,00
05 - VALE TRANSPORTE	R\$	-
06 - VALE ALIMENTAÇÃO	R\$	1.181,52
07 - TREINAMENTO E/OU RECICLAGEM DE PESSOAL	R\$	220,00
08 - SEGURO DE VIDA EM GRUPO	R\$	16,00
09 - PRÊMIO DE ASSIDUIDADE	R\$	160,05
10 - COMPENSAÇÃO INTERVALO INTRAJORNADA	R\$	1.368,91
11 - COTA DE APRENDIZAGEM (CLAU. 5ª, §12 DO ITA DA CCT 2023)	R\$	237,80
12 - CAIXA DE ASSISTENCIAL	R\$	240,00
SOMA DOS INSUMOS	R\$	3.925,28
13 - RESERVA TÉCNICA		
TOTAL DOS INSUMOS	R\$	3.925,28

TOTAL MÃO DE OBRA + INSUMOS	R\$	30.355,73
------------------------------------	------------	------------------

IV - DEMAIS COMPONENTES			
01 - DESPESAS ADMINISTRATIVAS/OPERACIONAIS	10,00%	R\$	3.035,57
02 - LUCRO	5,00%	R\$	1.669,57
SOMA DOS INSUMOS	15,00%	R\$	4.705,14

TOTAL GERAL ANTES DOS TRIBUTOS	R\$	35.060,87
---------------------------------------	------------	------------------

V. APURAÇÃO DO VALOR GLOBAL MENSAL:	
TOTAL GERAL ANTES DOS TRIBUTOS	R\$ 35.060,87

TRIBUTOS INCIDENTES SOBRE VALOR GLOBAL			
01 - COFINS	3,00%	R\$	1.151,42
02 - PIS	0,65%	R\$	249,48
03 - ISS	5,00%	R\$	1.919,04
TOTAL DOS TRIBUTOS	8,65%	R\$	3.319,94
VALOR MENSAL DO POSTO		R\$	38.380,81
VALOR HORA DO POSTO		R\$	53,31

Aracaju-SE, 01 de Fevereiro de 2024

Documento assinado digitalmente
gov.br REGINALDO BARRETO SILVA
Data: 31/01/2024 18:25:54-0300
Verifique em <https://validar.iti.gov.br>

REI SEGURANÇA PATRIMONIAL LTDA
CNPJ: 22.102.789/0002-05
Reginaldo Barreto Silva
CPF: 716.379.235-20
Diretor



PLANILHA 4 - EQUIPAMENTOS

DESCRIÇÃO	MARCA	MODELO	QUANT.	V. UNITÁRIO	SUBTOTAL
Camera Dome	Hikvision	DS-2CD2123G0-1(S)	44	R\$ 1.830,00	R\$ 80.520,00
Camera Bullet	Hikvision	DS-2CD1023G0E-1	45	R\$ 500,00	R\$ 22.500,00
Camera Speed Dome	Hikvision	DS-2DE7A432IW-AEB(T5)	1	R\$ 11.880,00	R\$ 11.880,00
Mesa Controladora	Hikvision	DS-1100KI(B)	1	R\$ 14.880,00	R\$ 14.880,00
NVR 8 canais	Hikvision	DS-7608NI-K2/8P	1	R\$ 3.900,00	R\$ 3.900,00
NVR 128 Canais	Hikvision	DS-96128NI-I16	1	R\$ 52.338,00	R\$ 52.338,00
Nobreak 1500VA	Ragtech	EASY PRO 1600VA	1	R\$ 4.880,00	R\$ 4.880,00
Nobreak 3200VA	Ragtech	EASY PRO 3200VA	2	R\$ 5.600,00	R\$ 11.200,00
SDC SERVER MONO			1	R\$ 110.826,00	R\$ 110.826,00
SDC SERVER WKS			1	R\$ 23.804,00	R\$ 23.804,00
SDC SERVER WKS			1	R\$ 26.866,00	R\$ 26.866,00
Licença Hikcentral Base com 64 Canais		HikCentral-P-VSS-Base/64Ch	1	R\$ 26.760,00	R\$ 26.760,00
Licença Modulo de 1 canal Hikcentral		HikCentral-P-VSS-1Ch	26	R\$ 466,00	R\$ 12.116,00
Monitor LED Full HD 23"			2	R\$ 1.504,00	R\$ 3.008,00
TV de 40" FullHD			4	R\$ 3.600,00	R\$ 14.400,00
Monitor 22"			1	R\$ 1.320,00	R\$ 1.320,00
HD 6TB			1	R\$ 3.304,40	R\$ 3.304,40
HD 10TB			4	R\$ 7.080,00	R\$ 28.320,00
TOTAL DOS EQUIPAMENTOS					R\$ 452.822,40
DEPRECIÇÃO MENSAL					R\$ 37.735,20

Aracaju-SE, 01 de Fevereiro de 2024

Documento assinado digitalmente

g vb

REGINALDO BARRETO SILVA

Data: 31/01/2024 18:25:54-0300

Verifique em <https://validar.iti.gov.br>

REI SEGURANÇA PATRIMONIAL LTDA

CNPJ: 22.102.789/0002-05

Reginaldo Barreto Silva

CPF: 716.379.235-20

Diretor

RELAÇÃO DOS TRABALHADORES CONSTANTES NO ARQUIVO SEFIP
MODALIDADE : "BRANCO"-RECOLHIMENTO AO FGTS E DECLARAÇÃO À PREVIDÊNCIA

858900002908 457101802403 107684180824 210278900011

EMPRESA:REI SEGURANCA PATRIMONIAL EIRELI
COMP:12/2023 COD REC:150 COD GPS:2100
TOMADOR/OBRA:SEINFRA

FPAS: 515

OUTRAS ENT:

SIMPLES: 1

RAT: 3,0

INSCRIÇÃO: 22.102.789/0001-24

FAP: 1,87 RAT AJUSTADO: 5,61

INSCRIÇÃO: 02.931.604/0001-87

NOME TRABALHADOR	REM SEM 13° SAL	REM 13°SAL	PIS/PASEP/CI BASE CÁL 13°SAL PREV SOC BASE CÁL PREV SOCIAL	ADMISSÃO CONTRIB SEG DEVIDA	CAT	OCOR	DATA/COD MOVIMENTAÇÃO DEPÓSITO	CBO JAM
AGNALDO DOS SANTOS ARAUJO	1.970,10	1.389,58	125.18193.90-3 0,00	16/11/2022 159,12	01		268,78	05173 0,00
CRISTIANO SILVA SANTIAGO	1.982,29	1.202,23	129.24618.19-5 0,66	16/11/2022 160,28	01		254,77	05173 0,00
EDNIR COUTINHO DA ANUNCIACAO	1.970,10	1.287,08	124.29212.28-7 0,00	17/11/2022 159,12	01		260,58	05173 0,00
ELENILTON DOS SANTOS PEREIRA DA CRUZ	2.430,29	771,83	130.39980.06-7 22,14	03/05/2023 202,62	01		256,17	05173 0,00
FERNANDO RIBEIRO DA SILVA	1.982,29	1.231,68	127.02524.06-2 0,11	16/11/2022 160,24	01		257,12	05173 0,00
GILNEI DE SANTANA COSTA	2.390,10	1.132,63	162.52210.63-4 22,88	17/11/2022 198,98	01		281,81	05173 0,00
JARDEL CONCEICAO DE ARAUJO	1.970,10	1.188,06	161.93593.35-8 0,93	16/11/2022 159,20	01		252,65	05173 0,00
JESIEL AMARAL DOS SANTOS	2.430,29	1.124,70	126.12898.60-5 28,60	16/11/2022 203,20	01		284,40	05173 0,00
JOSE AUGUSTO DA CONCEICAO FREITAS DE ALM	2.430,29	1.123,37	161.96448.58-8 28,91	18/11/2022 203,23	01		284,29	05173 0,00
LUCIANO DA SILVA FARIAS JUNIOR	2.390,10	1.276,70	164.19847.61-4 19,44	08/12/2022 198,67	01		293,34	05173 0,00
RAIMUNDO SOUZA DOS SANTOS	2.390,10	1.142,11	127.64689.06-5 21,06	17/11/2022 198,81	01		282,58	05173 0,00
TIAGO REIS DOS SANTOS	1.982,29	1.242,85	202.15047.72-3 1,49	01/01/2022 160,35	01		258,01	05173 0,00

TOTAIS DA EMPRESA/TOMADOR
26.318,34

14.112,82

146,22

2.163,82

3.234,50

0,00

RELAÇÃO DOS TRABALHADORES CONSTANTES NO ARQUIVO SEFIP
RESUMO DO FECHAMENTO - TOMADOR DE SERVIÇOS/OBRA
MODALIDADE : "BRANCO"-RECOLHIMENTO AO FGTS E DECLARAÇÃO À PREVIDÊNCIA

858900002908 457101802403 107684180824 210278900011

EMPRESA: REI SEGURANCA PATRIMONIAL EIRELI
COMP: 12/2023 COD REC:150 COD GPS: 2100
TOMADOR/OBRA: SEINFRA

FPAS: 515

OUTRAS ENT:

SIMPLES: 1

RAT: 3.0

Nº DE CONTROLE: D2BkuixFyGZ0000-1

Nº ARQUIVO: KDnW685npIT0000-6
INSCRIÇÃO: 22.102.789/0001-24
FAP: 1.87 RAT AJUSTADO: 5.61
INSCRIÇÃO: 02.931.604/0001-87

LOGRADOURO: URBIS II
CIDADE: ALAGOINHAS

UF: BA

CEP: 48031-060

BAIRRO: JARDIM PETROLAR

CNAE PREPONDERANTE: 8011101
CNAE: 8011101

CAT	QUANT	REMUNERAÇÃO SEM 13°	REMUNERAÇÃO 13°	BASE CÁL PREV SOC	BASE CÁL 13° PREV SOC
01	12	26.318,34	14.112,82	26.318,34	146,22
TOTAIS:	12	26.318,34	14.112,82	26.318,34	146,22

[Handwritten mark]

[Handwritten signature]

[Handwritten signature]

[Handwritten signature]

[Handwritten signature]



À

ASSEMBLÉIA LEGISLATIVA DO ESTADO DE SERGIPE

ANEXO V

DECLARAÇÃO DE COMPROMETIMENTO

Para fins de participação no processo de Licitação nº 01/2024- Pregão Presencial nº 01/2024, a empresa REI SEGURANÇA PATRIMONIAL LTDA, devidamente inscrita no CNPJ sob o nº 22.102.789/0001-24 e com filial inscrita no CNPJ sob o nº 22.102.789/0002-05, por intermédio de seu representante legal, o(a) Sr.(a.) Reginaldo Barreto Silva, portador(a) da Carteira de Identidade nº 533711193 e do CPF nº. 716.379.235-20, DECLARA QUE :

1. Aceita as condições do presente Edital, das disposições técnicas, bem como de sujeição às condições fixadas pela Assembleia Legislativa do Estado de Sergipe;
2. Nos preços propostos estão inclusas todas as despesas com deslocamentos, materiais, mão de obra, transportes, leis sociais, todos os tributos incidentes e demais encargos, enfim, todos os custos diretos e indiretos necessários para o fornecimento do objeto discriminado no Anexo I;
3. Tem o conhecimento da demanda e que as informações fornecidas são satisfatórias e corretas para o fornecimento do material de expediente dentro do prazo previsto;
4. Autoriza a Assembleia Legislativa do Estado de Sergipe proceder quaisquer diligências junto às instalações da empresa e sua contabilidade e a terceiros, os quais o licitante mantém transações comerciais;
5. Responderá pela veracidade das informações constantes da documentação e proposta que apresentar;
6. Declara que, após a emissão dos documentos que acompanham a proposta e os relativos à habilitação preliminar, não ocorreu fato que nos impeça de participar da mencionada licitação;

75 9 9958-1806
71 9 9228-1671

comercial@reiseguranca.com.br
www.reiseguranca.com.br

Tv. Eva Todor, nº 27, Bairro: Juracy Magalhães
Alagoinhas/Ba - CEP: 48005-254

[Handwritten signatures and initials]



7. Declara ainda que, atendemos aos critérios de qualidade ambiental e sustentabilidade socioambiental, respeitando as normas de proteção do meio ambiente;
8. Que se compromete a manter sigilo e confidencialidade de todas as informações, em especial, os dados pessoais e os dados pessoais sensíveis repassados em decorrência do processo em epígrafe em consonância com a Lei nº 13.709/2018 (Lei Geral de Proteção de Dados Pessoais – LGPD).
9. O prazo de validade desta proposta é de sessenta (60) dias, e o prazo de execução dos serviços é de acordo com as especificações dos Termos de Referência deste edital (ANEXO I), podendo ser prorrogado desde que justificado.

Alagoínhas-Ba, 31 de Janeiro de 2024

g v.b

Documento assinado digitalmente
REGINALDO BARRETO SILVA
Data: 31/01/2024 16:04:54 -0300
Verifique em <https://validar.iti.gov.br>

REI SEGURANÇA PATRIMONIAL LTDA

Reginaldo Barreto Silva

CPF: 716.379.235-20

Sócio-Diretor

75 9 9958-1806
71 9 9228-1671

comercial@reiseguranca.com.br
www.reiseguranca.com.br

Tv. Eva Todor, nº 27, Bairro: Juracy Magalhães
Alagoínhas/Ba - CEP: 48005-254



Soluções Inteligentes em
Vigilância e Segurança Patrimonial

À

ASSEMBLÉIA LEGISLATIVA DO ESTADO DE SERGIPE

DECLARAÇÃO DE CIÊNCIA E PLENO CONHECIMENTO

A empresa REI SEGURANÇA PATRIMONIAL LTDA, devidamente inscrita no CNPJ sob o nº 22.102.789/0001-24, sediada a TV Eva Todor, 27, Bairro Juracy Magalhães – CEP: 48.005-254 - Alagoinhas – BA e com filial inscrita no CNPJ sob o nº 22.102.789/0002-05, com endereço à Rua Aloísio Campos, 1320, Bairro Coroa do Meio – CEP: 49.035-131 – Aracaju – SE, declara sob as penas da lei, que, cumpre plenamente os requisitos de habilitação, como condição para a participação nesta licitação, conforme disposto no inciso II do art. 3º da Lei nº 5.848, de 13 de março de 2005.

Alagoinhas-Ba, 31 de Janeiro de 2024

g vb

Documento assinado digitalmente
REGINALDO BARRETO SILVA
Data: 31/01/2024 16:22:49-0300
Verifique em <https://validar.iti.gov.br>

REI SEGURANÇA PATRIMONIAL LTDA

Reginaldo Barreto Silva

CPF: 716.379.235-20

Sócio-Diretor

75 9 9958-1806
71 9 9228-1671

comercial@reiseguranca.com.br
www.reiseguranca.com.br

Tv. Eva Todor, nº 27, Bairro: Juracy Magalhães
Alagoinhas/Ba - CEP: 48005-254



Soluções Inteligentes em
Vigilância e Segurança Patrimonial

Á

ASSEMBLÉIA LEGISLATIVA DO ESTADO DE SERGIPE

DECLARAÇÃO - ANEXO III

A empresa REI SEGURANÇA PATRIMONIAL LTDA, devidamente inscrita no CNPJ sob o nº 22.102.789/0001-24 e com filial inscrita no CNPJ sob o nº 22.102.789/0002-05, por intermédio de seu representante legal, o(a) Sr.(a.) Reginaldo Barreto Silva, portador(a) da Carteira de Identidade nº 533711193 e do CPF nº. 716.379.235-20, declara sob as penas da lei, que, até a presente data, que dispomos de Aparelhamento, Equipamentos e Pessoal Técnico considerados essenciais para o cumprimento do objeto da Licitação.

Alagoinhas-Ba, 31 de Janeiro de 2024

g vb

Documento assinado digitalmente
REGINALDO BARRETO SILVA
Data: 31/01/2024 16:04:54-0300
Verifique em <https://validar.iti.gov.br>

REI SEGURANÇA PATRIMONIAL LTDA

Reginaldo Barreto Silva

CPF: 716.379.235-20

Sócio-Diretor

75 9 9958-1806
71 9 9228-1671

comercial@reisseguranca.com.br
www.reisseguranca.com.br

Tv. Eva Todor, nº 27, Bairro: Juracy Magalhães
Alagoinhas/Ba - CEP: 48005-254

[Handwritten signatures and initials]



Soluções Inteligentes em
Vigilância e Segurança Patrimonial

Á

ASSEMBLÉIA LEGISLATIVA DO ESTADO DE SERGIPE

DECLARAÇÃO - ANEXO IV

A empresa REI SEGURANÇA PATRIMONIAL LTDA, devidamente inscrita no CNPJ sob o nº 22.102.789/0001-24 e com filial inscrita no CNPJ sob o nº 22.102.789/0002-05, por intermédio de seu representante legal, o(a) Sr.(a.) Reginaldo Barreto Silva, portador(a) da Carteira de Identidade nº 533711193 e do CPF nº. 716.379.235-20, declara sob as penas da lei, que, até a presente data dispomos de 01 (um) veículo (s) comum com sistema de comunicação interrompida, conforme Art. 4º, V, Portaria 18045/2023.

Alagoinhas-Ba, 31 de Janeiro de 2024

g vb

Documento assinado digitalmente
REGINALDO BARRETO SILVA
Data: 31/01/2024 16:04:54-0300
Verifique em <https://validar.iti.gov.br>

REI SEGURANÇA PATRIMONIAL LTDA

Reginaldo Barreto Silva

CPF: 716.379.235-20

Sócio-Diretor

75 9 9958-1806
71 9 9228-1671

comercial@reiseguranca.com.br
www.reiseguranca.com.br

Tv. Eva Todor, nº 27, Bairro: Juracy Magalhães
Alagoinhas/Ba - CEP: 48005-254



Soluções Inteligentes em
Vigilância e Segurança Patrimonial

Á

ASSEMBLÉIA LEGISLATIVA DO ESTADO DE SERGIPE

DECLARAÇÃO DE VISTORIA

Declaramos, em cumprimento ao subitem “9.3.4” do EDITAL DO PREGÃO PRESENCIAL Nº 01/2023, que a empresa, REI SEGURANÇA PATRIMONIAL LTDA, devidamente inscrita no CNPJ sob o nº 22.102.789/0001-24, sediada a TV Eva Todor, 27, Bairro Juracy Magalhães – CEP: 48.005-254 -Alagoinhas – BA e com filial inscrita no CNPJ sob o nº 22.102.789/0002-05, com endereço à Rua Aloísio Campos, 1320, Bairro Coroa do Meio – CEP: 49.035-131 – Aracaju – SE, por intermédio de seu representante legal, o(a) Sr.(a.) Reginaldo Barreto Silva, portador(a) da Carteira de Identidade nº 533711193 e do CPF nº. 716.379.235-20, DECLARA que optou por não visitar os locais onde serão prestados os serviços de vigilância e instalados os equipamentos, objeto da licitação, ciente de que não podemos alegar, futuramente, o desconhecimento das condições e o grau de dificuldade existentes, como justificativa para se eximir das obrigações assumidas, bem como de questionamentos que ensejem avenças técnicas ou financeiras com a Contratante, em conformidade com o disposto no Acórdão TCU 1.174/2008.

Alagoinhas-Ba, 31 de Janeiro de 2024



Documento assinado digitalmente
REGINALDO BARRETO SILVA
Data: 31/01/2024 16:16:42-0300
Verifique em <https://validar.iti.gov.br>

REI SEGURANÇA PATRIMONIAL LTDA

Reginaldo Barreto Silva

CPF: 716.379.235-20

Sócio-Diretor

75 9 9958-1806
71 9 9228-1671

comercial@reiseguranca.com.br
www.reiseguranca.com.br

Tv. Eva Todor, nº 27, Bairro: Juracy Magalhães
Alagoinhas/Ba - CEP: 48005-254

[Handwritten signatures and initials]



Soluções Inteligentes em
Vigilância e Segurança Patrimonial

ASSEMBLÉIA LEGISLATIVA DO ESTADO DE SERGIPE
PROPOSTA DE PREÇOS
ESPECIFICAÇÕES

[Handwritten signature]

[Handwritten mark]

[Handwritten mark]

[Handwritten mark]

[Handwritten mark]

[Handwritten mark]

[Handwritten signature]

[Handwritten signature]

75 9 9958-1806
71 9 9228-1671

comercial@reiseguranca.com.br
www.reiseguranca.com.br

Tv. Eva Todor, nº 27, Bairro: Juracy Magalhães
Alagoinhas/Ba - CEP: 48005-254

DS-96128NXI-I16 (C) DeepinMind NVR

Key Feature

- Up to 48-ch facial recognition for video stream, or up to 96-ch facial recognition for face picture
- Up to 48-ch video structuralization
- Up to 64 libraries and 500,000 face pictures
- Up to 96-ch human and vehicle recognition of perimeter protection to reduce false alarms
- Up to 32-ch throwing objects from building
- Up to 128-ch network camera inputs
- Up to 512 Mbps incoming and outgoing bandwidth
- Up to 20-ch@1080p decoding capability
- 16 SATA interfaces (up to 10 TB capacity for each HDD)
- HDD hot swapping with RAID 0/1/5/6/10
- Redundant power supply
- 7-inch LCD touch-screen

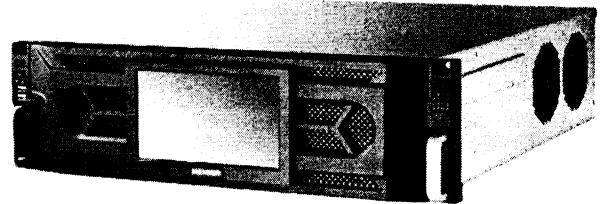

Profession and Reliability

- H.265+ compression effectively reduces the storage space by up to 75%
- Adopt professional embedded hardware (Intel® processor) and software, and pioneering dual-OS design to ensure the reliability of system running.
- Redundant power supply ensures system stability
- ANR (Automatic Network Replenishment) technology enhances storage reliability when network exception occurs
- Adopt stream over TLS encryption technology which provides more secure stream transmission service
- Support double verification for playback and downloading

Video and Storage

- Compatible with third-party network cameras, such as ACTI, Arecont, AXIS, Bosch, Brickcom, Canon, ONVIF, PANASONIC, Pelco, SAMSUNG, SANYO, SONY, Vivotek and ZAVIO
- 16 SATA interfaces (up to 10 TB capacity per HDD), 1 eSATA interface and 2 miniSAS interfaces are provided for HDD connection



Network & Ethernet Access

- 4 self-adaptive 10M/100M/1000M Ethernet interfaces
- Hik-Connect & DDNS (Dynamic Domain Name System) for easy network management
- 4 gigabit Ethernet SFP fiber interfaces
- Smooth streaming technology
- Support web access without plug-in

Live view and Playback

- Up to 20-ch@1080p decoding for live view
- Up to 16-ch synchronous playback at 1080p resolution
- Dual 4K (4096 × 2160) HDMI outputs

Application and Management

- Centralized management of network cameras, including configuration, information import/export, real-time information display, two-way audio, upgrade, etc.
- Configurable network camera smart functions, such as VCA detection (motion, line crossing, intrusion, etc.), heat map, ANPR, and people counting
- Deep learning based video analytics for false alarm reduction, facial recognition and face picture comparison
- VCA search for facial detection, false alarm reduction, people counting and heat map

Typical Application

Facial Recognition and Face Picture Comparison

Modeling and analyzing face pictures captured by cameras. Realize list alarm and stranger alarm via face picture library. Search target people by picture and name features.

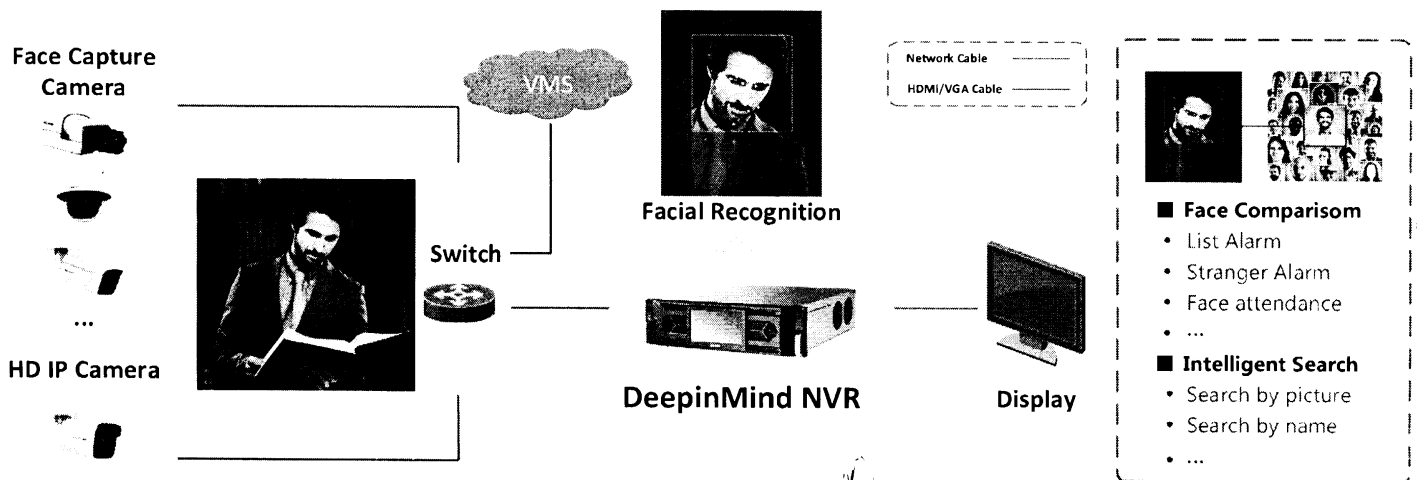

Handwritten signatures and marks at the bottom right of the page.

Perimeter Protection

Adopt deep learning algorithm to reduce false alarm, effectively reduces the false alarm caused by tree branches, leaves, shadow, light, vehicles, small animals, etc.

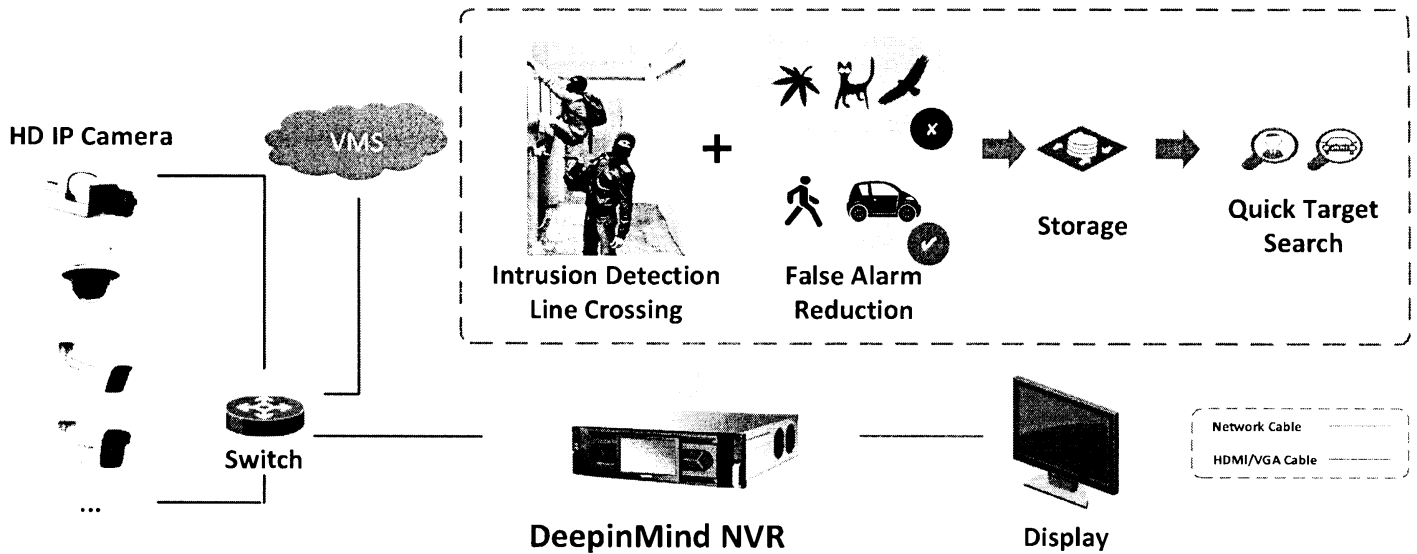

Video Structuralization

Extracting the face picture, human body and vehicle features from live videos, which is used for the tracking and retrieval of human and vehicles.

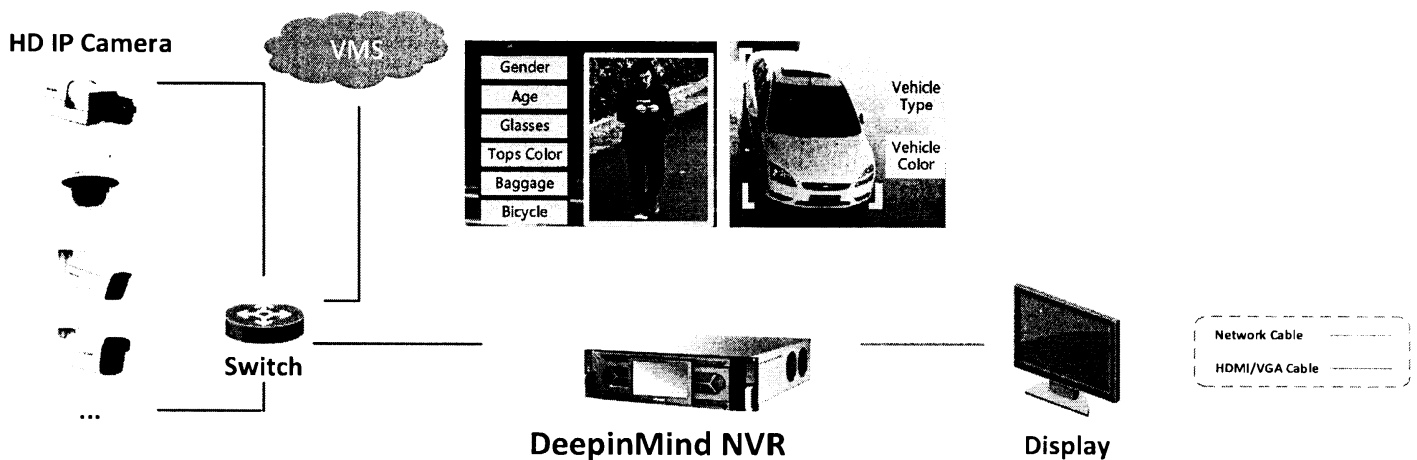

Handwritten signatures and marks:

HL

7

[Signature]

[Signature]

Specification

Model	iDS-96128NXI-I16
Facial Recognition	
Facial detection and analytics	Face picture comparison, human face capture, face picture search
Face picture library	Up to 64 face picture libraries, with up to 500,000 face pictures in total (each picture ≤ 6 MB, total capacity ≤ 40 GB)
Face picture comparison	96-ch face picture comparison alarm
Performance of facial detection and analytics	48-ch 4 MP human face capture (HD network camera, up to 8 MP, H.264/H.265)
Perimeter Protection	
Human/Vehicle analysis	Up to 96-ch 2 MP (H.264/H.265) video analysis for human and vehicle recognition to reduce false alarm
Video Structuralization	
Structured analysis	Up to 48-ch 2 MP (H.264/H.265) video structured analysis
Throwing Objects from Building	
Capability	Up to 32-ch 2 MP (H.264/H.265) video analysis
Video and Audio	
IP video input	128-ch Up to 12 MP resolution *: When ultra HD resolution mode is enabled, 32 MP and 24 MP is only available for channel 1 to channel 4.
Incoming bandwidth	512 Mbps
Outgoing bandwidth	512 Mbps
HDMI 1 output	4K (4096 × 2160)/30Hz, 4K (3840 × 2160)/30Hz, 2K (2560 × 1440)/60Hz, 1920 × 1080/60Hz, 1600 × 1200/60Hz, 1280 × 1024/60Hz, 1280 × 720/60Hz, 1024 × 768/60Hz
HDMI 2 output	4K (4096 × 2160)/30Hz, 4K (3840 × 2160)/30Hz, 2K (2560 × 1440)/60Hz, 1920 × 1080/60Hz, 1600 × 1200/60Hz, 1280 × 1024/60Hz, 1280 × 720/60Hz, 1024 × 768/60Hz
VGA output	1-ch, 1920 × 1080/60Hz, 1600 × 1200/60Hz, 1280 × 1024/60Hz, 1280 × 720/60Hz, 1024 × 768/60Hz
LCD output	7-inch LCD
Audio input	1-ch, RCA (2.0 Vp-p, 1 KΩ)
Audio output	1-ch, RCA (2.0 Vp-p, 1 KΩ)
Two-way audio input	1-ch, RCA (2.0 Vp-p, 1 k Ω)
Decoding	
Decoding format	H.265+/H.265/H.264+/H.264/MJPEG/MPEG4 32 MP/24 MP/12 MP/8 MP/7 MP/6 MP/5 MP/4 MP/3 MP/1080p/UXGA/720p/VGA/4CIF/DCIF/2CIF/CIF/QCIF
Recording resolution	32 MP and 24 MP is only available for channel 1 to 4 when ultra HD resolution mode is enabled.
Synchronous playback	16-ch
Capability	1-ch@32 MP (8160 × 3616, 30 fps)/5-ch@8 MP(30 fps)/10-ch@4 MP(30 fps)/20-ch@1080p(30 fps)/40-ch@720p(30 fps) *: The length or width of camera resolution (each track) cannot exceed 4096 pixels.

Handwritten initials

Handwritten signatures and marks

Dual-stream recording	Support
Stream type	Video, Video & Audio
Audio compression	G.711ulaw/G.711alaw/G.722/G.726/MP2L2
Network	
Remote connections	256
Network protocol	TCP/IP, DHCP, IPv4, IPv6, DNS, DDNS, NTP, RTSP, SADP, SMTP, SNMP, NFS, iSCSI, ISUP, UPnP™, HTTP, HTTPS
Network interface	4, RJ-45 10/100/1000 Mbps self-adaptive Ethernet interface
RAID	
RAID Type	RAID0, RAID1, RAID5, RAID6, and RAID10 (at least 4 TB for each HDD)
Auxiliary Interface	
Fiber interface	4, gigabit Ethernet SFP interface (on extension board)
Serial port	RS-232; RS-485 (full-duplex); Keyboard
SATA	16 SATA interfaces supporting hot-plug
Capacity	Up to 10 TB capacity for each disk
eSATA	1 eSATA interface
MiniSAS	2 miniSAS interfaces
Alarm in/out	48/24 (main board: 16/8; extension board: 32/16)
USB interface	Front panel: 2 × USB 2.0; Rear panel: 2 × USB 3.0
Extension board	1; With 4 × gigabit Ethernet SFP interfaces, 8 × RS-485 (full-duplex), 32 alarm inputs, and 16 alarm outputs
General	
Processor	Quad-Core Intel® Xeon® E3
Memory	8 GB
Power supply	100 to 240 VAC, 50 to 60Hz, 5 A
Fan	Dual ball bearing fan; Speed adjustable
Consumption (without HDD)	≤ 140W
Working temperature	0 °C to 50 °C (32 °F to 122 °F)
Working humidity	10% to 90%
Dimension (W × D × H)	446 × 495 × 133 mm (17.6 × 19.5 × 5.2 inch)
Weight (without HDD)	≤ 23 kg (50.7 lb)
Certification	
Obtained Certification	CE, FCC, CB, WEEE
FCC	Part 15 Subpart B, ANSI C63.4
CE	EN 55032:2015, EN 61000-3-2, EN 61000-3-3, EN 50130-4

Handwritten initials

Handwritten signatures and marks

Dimension

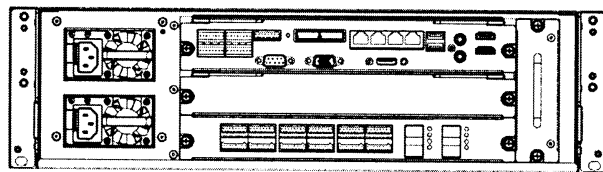
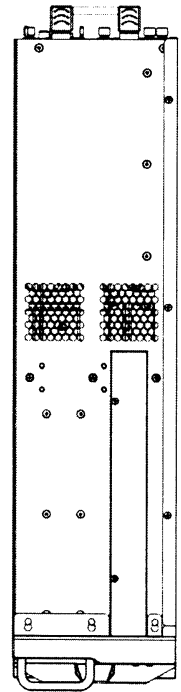
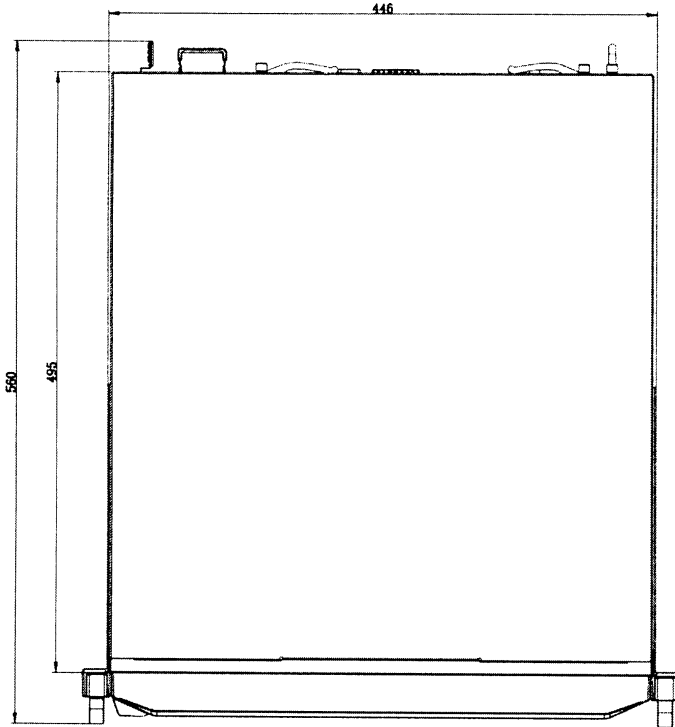
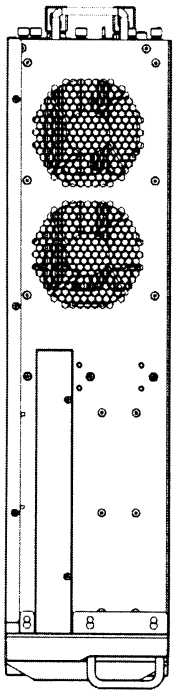
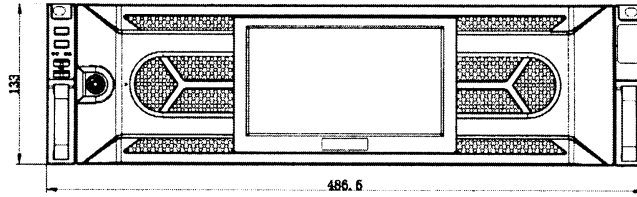

Handwritten mark

Unit: mm

Handwritten signatures and marks

Physical Interface

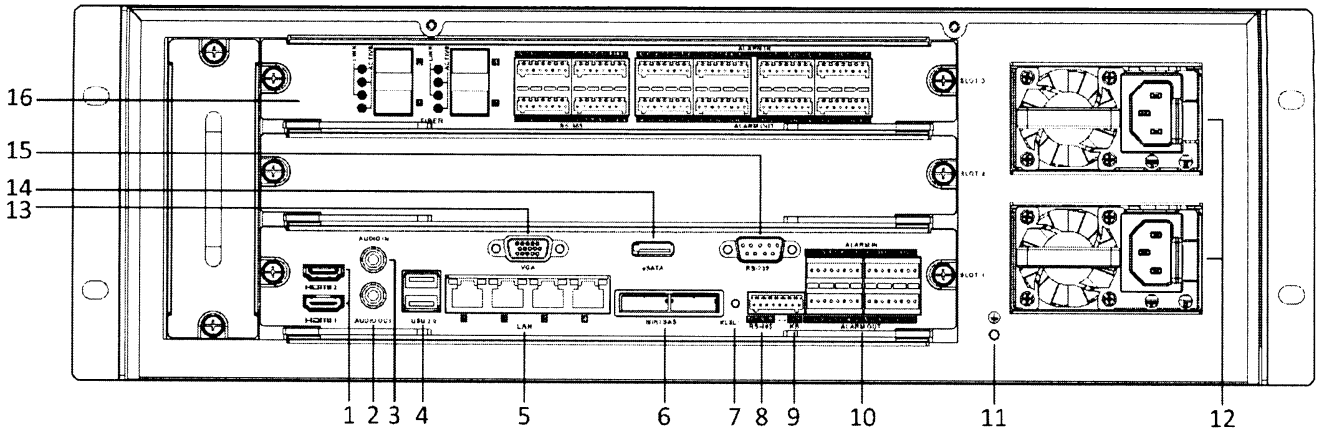

No.	Description	No.	Description
1	HDMI 1/HDMI 2 Interface	9	Keyboard Interface
2	AUDIO OUT, RCA Connector	10	ALARM IN/OUT
3	AUDIO IN, RCA Connector	11	Ground
4	USB 3.0 Interface	12	100 to 240 VAC Power Supply
5	LAN Network Interface	13	VGA Interface
6	MiniSAS Interface	14	eSATA Interface
7	Reset Button	15	RS-232 Interface
8	RS-485 Interface	16	Extension Board

fil

A
B
Power

Available Model

iDS-96128NXI-I16 (C)

Distributed by



04601102020218

HIKVISION

Headquarters

No.555 Qianmo Road, Binjiang District,
Hangzhou 310051, China
T +86 571 8807 5009
overseasbusiness@hikvision.com

Hikvision USA
T +1 909 806 9400
usa@hikvision.com

Hikvision Australia
T +61 2 9599 4333
au@hikvision.com

Hikvision India
T +91 22 26460000
india@hikvision.com

Hikvision Canada
T +1 416 209 0000
canada@hikvision.com

Hikvision Thailand
T +66 2 275 9949
thailand@hikvision.com

Hikvision Europe
T +31 23 5542 070
europe@hikvision.com

Hikvision Italy
T +39 0432 51000
italy@hikvision.com

Hikvision Brazil
T +55 11 3316 0000
brazil@hikvision.com

Hikvision Turkey
T +90 312 415 7074
turkey@hikvision.com

Hikvision Malaysia
T +601 7652 2413
malaysia@hikvision.com

Hikvision UK & Ireland
T +44 1875 802140
uk@hikvision.com

Hikvision South Africa
T +27 101 001122
sa@hikvision.com

Hikvision France
T +33 01 48 58 400
france@hikvision.com

Hikvision Kazakhstan
T +7 727 676682
kazakhstan@hikvision.com

Hikvision Vietnam
T +84 3742 7666
vietnam@hikvision.com

Hikvision UAE
T +971 4 443 000
uae@hikvision.com

Hikvision Singapore
T +65 6391 4718
sg@hikvision.com

Hikvision Spain
T +34 91 267 1666
spain@hikvision.com

Hikvision Tashkent
T +99 67 1236 9498
tashkent@hikvision.com

Hikvision Hong Kong
T +852 2151 1281
hk@hikvision.com

Hikvision Russia
T +7 495 489 6744
russia@hikvision.com

Hikvision Korea
T +82 40 317 01 000
korea@hikvision.com

Hikvision Poland
T +48 22 469 0100
poland@hikvision.com

Hikvision Indonesia
T +62 21 2932358
indonesia@hikvision.com

Hikvision Colombia
sales.colombia@hikvision.com

S-2CD1023G0E-I

MP Fixed Bullet Network Camera

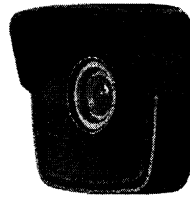

HIKVISION

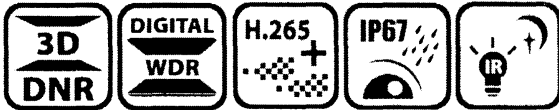

- High quality imaging with 2 MP resolution
- Efficient H.265+ compression technology
- Clear imaging against strong back light due to DWDR technology
- Water and dust resistant (IP67)
- EXIR 2.0: advanced infrared technology with long IR range

[Handwritten mark]



[Handwritten signatures and marks]

▪ Specification

Camera

Image Sensor	1/2.7" Progressive Scan CMOS
Min. Illumination	Color: 0.01 Lux @(F2.0, AGC ON), B/W: 0 Lux with IR
Shutter Speed	1/3 s to 1/100,000 s
Slow Shutter	Yes
Wide Dynamic Range	Digital WDR
Day & Night	IR cut filter
Angle Adjustment	Pan: 0° to 360°, tilt: 0° to 180°, rotate: 0° to 360°

Lens

Focal Length & FOV	2.8 mm, horizontal FOV 112.1°, vertical FOV 60.0°, diagonal FOV 132.2° 4 mm, horizontal FOV 90.2°, vertical FOV 48.6°, diagonal FOV 107.6°
Lens Mount	M12
Focus	Fixed
Aperture	F2.0

Illuminator

IR Wavelength	850 nm
IR Range	Up to 30 m

Video

Max. Resolution	1920 × 1080
Main Stream	50 Hz: 25 fps (1920 × 1080, 1280 × 720) 60 Hz: 30 fps (1920 × 1080, 1280 × 720)
Sub-Stream	50 Hz: 25 fps (640 × 480, 640 × 360) 60 Hz: 30 fps (640 × 480, 640 × 360)
Video Compression	Main Stream: H.265/H.264 Sub-Stream: H.265/H.264/MJPEG
Video Bit Rate	32 Kbps to 8 Mbps
H.264 Type	Baseline Profile/Main Profile/High Profile
H.265 Type	Main Profile
H.264+	Main Stream supports
H.265+	Main Stream supports
Region of Interest (ROI)	1 fixed region for main stream

Network

Protocols	TCP/IP, ICMP, HTTP, HTTPS, FTP, DHCP, DNS, DDNS, RTP, RTSP, RTCP, NTP, UPnP™, SMTP, IGMP, 802.1X, QoS, IPv6, Bonjour, IPv4, UDP, SSL/TLS
Simultaneous Live View	Up to 6 channels
API	Open Network Video Interface, ISAPI
User/Host	Up to 32 users. 3 levels: administrator, operator and user
Client	iVMS-4200, Hik-Connect Plug-in required live view: IE 10+
Web Browser	Plug-in free live view: Chrome 57.0+, Firefox 52.0+ Local service: Chrome 57.0+, Firefox 52.0+

Image

Image Settings	Saturation, brightness, contrast, sharpness, AGC, white balance adjustable by client software or web browser.
----------------	---

Day/Night Switch	Day, Night, Auto, Schedule
Image Enhancement	BLC, 3D DNR
Interface	
Ethernet Interface	1 RJ45 10 M/100 M self-adaptive Ethernet port
Event	
Basic Event	Motion detection, video tampering alarm, exception
General	
Linkage Method	Upload to FTP, notify surveillance center, send email
Camera Material	Metal & Plastic
Camera Dimension	177.6 mm × 66.2 mm × 67.8 mm (7.0" × 2.6" × 2.7")
Package Dimension	216 mm × 121 mm × 118 mm (8.5" × 4.8" × 4.6")
Camera Weight	Approx. 270 g (0.6 lb.)
With Package Weight	Approx. 490 g (1.1 lb.)
Storage Conditions	-30 °C to 60 °C (-22 °F to 140 °F). Humidity: 95% or less (non-condensing)
Startup and Operating Conditions	-30 °C to 60 °C (-22 °F to 140 °F). Humidity: 95% or less (non-condensing)
Web Client Language	English, Ukrainian
General Function	Anti-flicker, heartbeat, mirror, password protection, privacy mask, watermark, IP address filter
Firmware Version	V5.5.120
Power Consumption and Current	12 VDC, 0.4 A, max. 5 W PoE: (802.3af, 36 V to 57 V), 0.2 A to 0.15 A, max. 6.5 W
Power Supply	12 VDC ± 25% PoE: 802.3af, Class 3
Power Interface	Ø5.5 mm coaxial power plug
Approval	
EMC	FCC SDoC (47 CFR Part 15, Subpart B); CE-EMC (EN 55032: 2015, EN 61000-3-2: 2014, EN 61000-3-3: 2013, EN 50130-4: 2011 +A1: 2014); RCM (AS/NZS CISPR 32: 2015); IC VoC (ICES-003: Issue 6, 2016); KC (KN 32: 2015, KN 35: 2015)
Safety	UL (UL 60950-1); CB (IEC 60950-1:2005 + Am 1:2009 + Am 2:2013, IEC 62368-1:2014); CE-LVD (EN 60950-1:2005 + Am 1:2009 + Am 2:2013, IEC 62368-1:2014); BIS (IS 13252(Part 1):2010+A1:2013+A2:2015)
Environment Protection	CE-RoHS (2011/65/EU); WEEE (2012/19/EU); Reach (Regulation (EC) No 1907/2006) IP67 (IEC 60529-2013)

▪ **Available Model**

DS-2CD1023G0E-I(2.8/4 mm)

Dimension

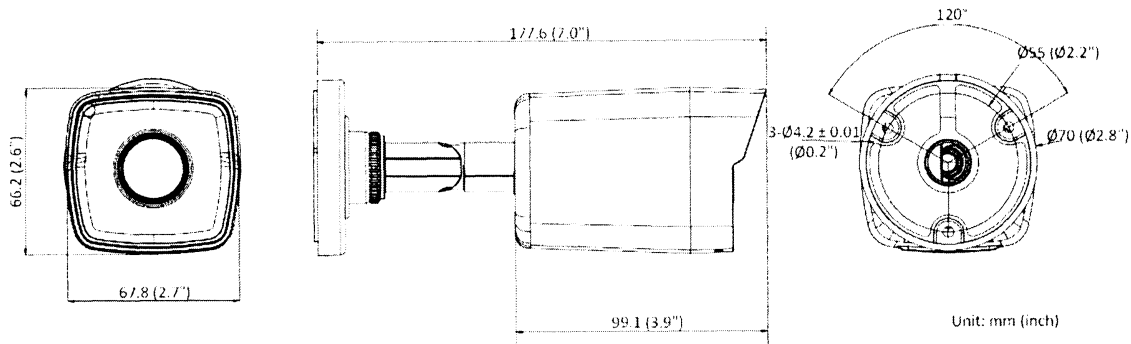

Accessory

Optional

DS-1280ZJ-XS Junction Box



Distributed by



HIKVISION

Headquarters

No.555 Qianma Road, Binjiang District,
Hangzhou 310051, China
T +86-571-8607-5998
overseasbusiness@hikvision.com

Hikvision USA

T +1-800-393-0400
sales.usa@hikvision.com

Hikvision Australia

T +61-2-8559-4233
sales.au@hikvision.com

Hikvision India

T +91-22-25963900
sales@pram@hikvision.com

Hikvision Canada

T +1-800-200-6990
sales.canada@hikvision.com

Hikvision Thailand

T +66-2-275-9966
sales.thailand@hikvision.com

Hikvision Europe

T +31-20-6942770
sales.eu@hikvision.com

Hikvision Italy

T +39-0438-8000
info.it@hikvision.com

Hikvision Brazil

T +55-11-5518-0050
latam.support@hikvision.com

Hikvision Turkey

T +90-216-521-0070-7074
sales.tr@hikvision.com

Hikvision Malaysia

T +601-262-2413
sales.my@hikvision.com

Hikvision UK & Ireland

T +01626-842100
sales.uk@hikvision.com

Hikvision South Africa

Tel: +271101051172
sales.africa@hikvision.com

Hikvision France

T +33(0)1-69-40-440
info.fr@hikvision.com

Hikvision Kazakhstan

T +7-727-3781007
nikla.pantlov@hikvision.ru

Hikvision Vietnam

T +84-87477008
sales.vn@hikvision.com

Hikvision UAE

T +971-4-4432030
sales.ae@hikvision.com

Hikvision Singapore

T +65-6684-4718
sg@hikvision.com

Hikvision Spain

T +34-91-737-16-55
info.es@hikvision.com

Hikvision Tashkent

T +99-97-1238-9438
uzb@hikvision.ru

Hikvision Hong Kong

T +852-2151-1761
hk@hikvision.com

Hikvision Russia

T +7-495-661-07-99
sales.ru@hikvision.com

Hikvision Korea

T +82-10171-731-8217
sales.korea@hikvision.com

Hikvision Poland

T +48-22-651-01-50
info.pl@hikvision.com

Hikvision Indonesia

T +62-21-29337559
Sales.indonesia@hikvision.com

Hikvision Colombia

sales.colombia@hikvision.com

DS-2CD2123G0-I(S)

2 MP IR Fixed Dome Network Camera

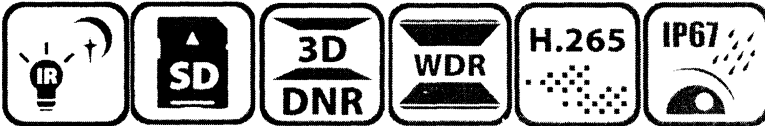
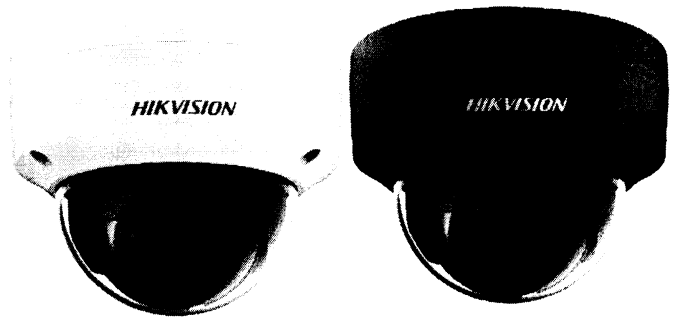

Key Features

- 1/2.8" Progressive Scan CMOS
- 1920 × 1080@30fps
- 2.8/4/6/8 mm fixed lens
- Color: 0.01 Lux @ (F1.2, AGC ON), 0.028 Lux @ (F2.0, AGC ON), 0 Lux with IR
- H.265+, H.265, H.264+, H.264
- Three streams
- 120dB WDR
- 2 Behavior analyses, and face detection
- BLC/3D DNR/ROI/HLC
- IP67, IK10
- Built-in micro SD/SDHC/SDXC card slot, up to 128 GB
- 3-Axis adjustment

fo

Handwritten signature

Handwritten signature

Handwritten signature



Specifications

Camera

Image Sensor	1/2.8" Progressive Scan CMOS
Min. Illumination	Color: 0.01 Lux @ (F1.2, AGC ON), 0.028 Lux @ (F2.0, AGC ON), 0 Lux with IR
Shutter Speed	1/3 s to 1/100,000 s
Slow Shutter	Yes
Day & Night	IR Cut Filter
Digital Noise Reduction	3D DNR
WDR	120dB
3-Axis Adjustment	Pan: 0° to 355°, tilt: 0° to 75°, rotate: 0° to 355°

Lens

Focal length	2.8/4/6/8 mm
Aperture	F2.0
Focus	Fixed
FOV	2.8 mm, horizontal FOV: 114°, vertical FOV: 62°, diagonal FOV: 135° 4 mm, horizontal FOV: 86°, vertical FOV: 46°, diagonal FOV: 102° 6 mm, horizontal FOV: 54°, vertical FOV: 30°, diagonal FOV: 62° 8 mm, horizontal FOV: 43°, vertical FOV: 23°, diagonal FOV: 50°
Lens Mount	M12

IR

IR Range	Up to 30 m
Wavelength	850nm

Compression Standard

Video Compression	Main stream: H.265/H.264 Sub-stream: H.265/H.264/MJPEG Third stream: H.265/H.264
H.264 Type	Main Profile/High Profile
H.264+	Main stream supports
H.265 Type	Main Profile
H.265+	Main stream supports
Video Bit Rate	32 Kbps to 16 Mbps
Audio Compression (-S)	G722.1/G.711/G726/MP2L2/PCM/MP3
Audio Bit Rate (-S)	64Kbps(G.711)/16Kbps(G.722.1)/16Kbps(G.726)/32-192Kbps(MP2L2)/8Kbps-320Kbps(MP3)

Smart Feature-set

Smart Event	Line crossing detection, intrusion detection, face detection
Basic Event	Motion detection, video tampering alarm, exception (network disconnected, IP address conflict, illegal login, HDD full, HDD error)
Linkage Method	Trigger recording: memory card, network storage, pre-record and post-record Trigger captured pictures uploading: FTP, HTTP, NAS, Email Trigger notification: HTTP, ISAPI, alarm output (-S), Email
Region of Interest	1 fixed region for main stream and sub-stream

Image

Max. Resolution	1920 × 1080
Main Stream	50Hz: 25fps (1920 × 1080, 1280 × 960, 1280 × 720) 60Hz: 30fps (1920 × 1080, 1280 × 960, 1280 × 720)
Sub-Stream	50Hz: 25fps (640 × 480, 640 × 360, 320 × 240)

Handwritten signatures and initials are present in the bottom right corner of the page, including a large signature and several smaller initials.

Third Stream	60Hz: 30fps (640 × 480, 640 × 360, 320 × 240) 50Hz: 25fps (1920 × 1080, 1280 × 720, 640 × 360, 352 × 288) 60Hz: 30fps (1920 × 1080, 1280 × 720, 640 × 360, 352 × 240)
Image Enhancement	BLC/3D DNR/HLC
Image Setting	Rotate mode, saturation, brightness, contrast, sharpness, AGC, and white balance adjustable by client software or web browser
Target Cropping	No
Day/Night Switch	Day/Night/Auto/Schedule/Triggered by alarm in (-S)
Network	
Network Storage	Support Micro SD/SDHC/SDXC card (128G), local storage and NAS (NFS,SMB/CIFS), ANR
Protocols	TCP/IP, UDP, ICMP, HTTP, HTTPS, FTP, DHCP, DNS, DDNS, RTP, RTSP, RTCP, PPPoE, NTP, UPnP, SMTP, SNMP, IGMP, 802.1X, QoS, IPv6, UDP, Bonjour, SSL/TLS, WebSocket, WebSockets
General Function	Anti-flicker, three streams, heartbeat, mirror, privacy masks, password reset via e-mail, pixel counter, HTTP listening
API	ONVIF (PROFILE S, PROFILE G, PROFILE T), ISAPI, SDK
Security	Password protection, complicated password, HTTPS encryption, 802.1X authentication (EAP-TLS 1.2, EAP-LEAP, EAP-MD5), watermark, IP address filter, basic and digest authentication for HTTP/HTTPS, WSSE and digest authentication for ONVIF, TLS1.2
Simultaneous Live View	Up to 6 channels
User/Host	Up to 32 users 3 levels: Administrator, Operator and User
Client	iVMS-4200, Hik-Connect, Hik-Central
Web Browser	Plug-in required live view: IE8+ Plug-in free live view: Chrome 57.0+, Firefox 52.0+, Safari 11+ Local Service: Chrome 41.0+, Firefox 30.0+
Interface	
Audio (-S)	1 input (line in/mic in), 1 output (line out), terminal block, mono sound
Communication Interface	1 RJ45 10M/100M self-adaptive Ethernet port
Alarm (-S)	1 input, 1 output (max. 12 VDC, 30 mA), terminal block
Video Output	No
On-board storage	Built-in Micro SD/SDHC/SDXC slot, up to 128 GB
SVC	H.264 and H.265 encoding
Reset Button	Yes
Audio (-S)	
Environment Noise Filtering	Yes
Audio Sampling Rate	8kHz/16 kHz/32 kHz/44.1 kHz/48 kHz
General	
Operating Conditions	-30 °C to +60 °C (-22 °F to +140 °F), Humidity 95% or less (non-condensing) 32 languages
Web Client Language	English, Russian, Estonian, Bulgarian, Hungarian, Greek, German, Italian, Czech, Slovak, French, Polish, Dutch, Portuguese, Spanish, Romanian, Danish, Swedish, Norwegian, Finnish, Croatian, Slovenian, Serbian, Turkish, Korean, Traditional Chinese, Thai, Vietnamese, Japanese, Latvian, Lithuanian, Portuguese (Brazil)
Power Supply	12 VDC ± 25%, Ø 5.5 mm coaxial power plug PoE (802.3af, class 3)
Power Consumption and Current	12 VDC, 0.5 A, max. 6 W PoE (802.3af, 36 V to 57 V), 0.2 A to 0.1 A, max. 7.5 W
Protection Level	IP67, IK10

Handwritten signatures and initials are present at the bottom right of the page, including a large signature and the word "Solomon" written vertically.

Material	Camera body: metal, bubble: plastic
Dimensions	Camera: $\Phi 111 \times 82.4$ mm ($\Phi 4.4" \times 3.2"$)
	Package: $134 \times 134 \times 108$ mm ($5.3" \times 5.3" \times 4.3"$)
Weight	Camera: Approx. 610 g (1.3 lb.)
	With Package: Approx. 820 g (1.8 lb.)

Available Model:

DS-2CD2123G0-I (2.8/4/6/8 mm), DS-2CD2123G0-IS (2.8/4/6/8 mm)

Dimension

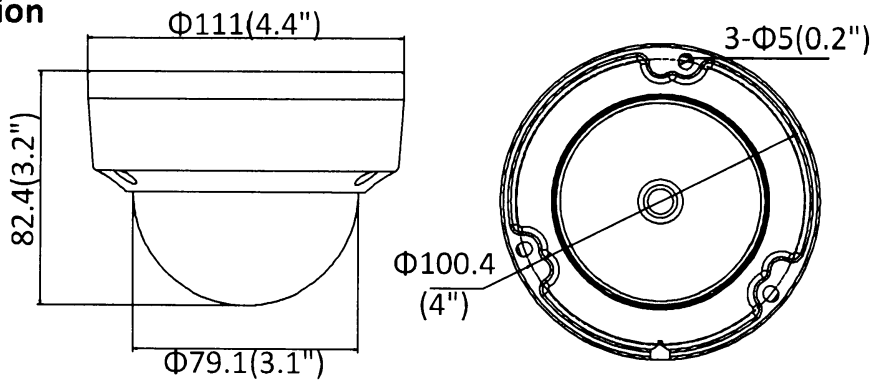

Unit: mm (inch)

Accessory

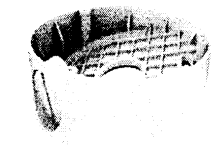

Inclined Ceiling Mount
DS-1259ZJ

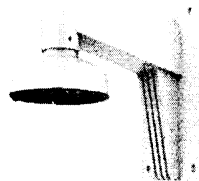

Wall Mount
DS-1272ZJ-110

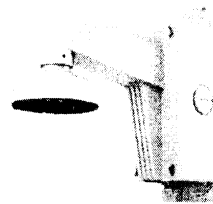

Wall Mount + Junction Box
DS-1272ZJ-110B



Pendant Mount
DS-1271ZJ-110

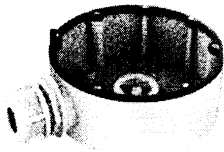

Junction Box
DS-1280ZJ-DM18

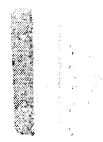

Corner Mount
DS-1276ZJ-SUS



Vertical Pole Mount
DS-1275ZJ



Rain-proof Cap
DS-1250ZJ

ful

[Handwritten signature]

[Handwritten signature]

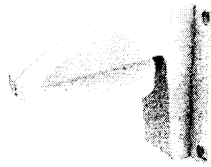

Wall Mount
DS-1258ZJ



Inclined Ceiling Mount
DS-1259ZJ(Black)



Pendant Mount
DS-1271ZJ-110(Black)

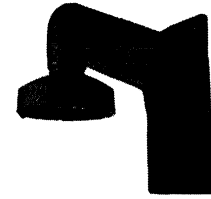

Wall Mount
DS-1272ZJ-110(Black)



Corner Mount
DS-1276ZJ-SUS(Black)



Junction Box
DS-1280ZJ-DM18(Black)

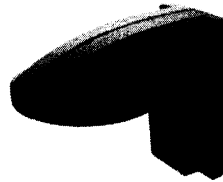

Wall Mount
DS-1258ZJ(Black)



Vertical Pole Mount
DS-1275ZJ-SUS(Black)

Distributed by



HIKVISION

Headquarters

No.555 Qianmo Road, Binjiang District,
Hangzhou 310051, China
T +86-571-8807-5998
overseasbusiness@hikvision.com

Hikvision USA
T +1-800-896-0400
sales.usa@hikvision.com

Hikvision Italy
T +39-0435-6102
info.it@hikvision.com

Hikvision Singapore
T +65-6094-6718
sg@hikvision.com

Hikvision Africa
T +27(11) 033-1172
sales.africa@hikvision.com

Hikvision Europe
T +31-23-65-42-770
info.eu@hikvision.com

Hikvision France
T +33(0)1-35-304-450
info.fr@hikvision.com

Hikvision Oceania
T +61-2-9595-4000
sales.au@hikvision.com

Hikvision Hong Kong
T +852-2161-1761

Hikvision Middle East
T +971-4-8810085
sales.me@hikvision.com

Hikvision Spain
T +34-91-737-16-55
info.es@hikvision.com

Hikvision Canada
T +1-708-870-1400
sales.usa@hikvision.com

Hikvision Russia
T +7-495-660-57-33
sales.ru@hikvision.com

Hikvision Poland
T +48-22-600-01-50
poland@hikvision.com

Hikvision Korea
T +82-31-731-5641
sales.korea@hikvision.com

Hikvision India
T +91-22-26463900
sales@pramanik-vision.com

Hikvision UK
T +01628-902140
support.uk@hikvision.com

Hikvision Brazil
T +55-11-3518-0050
latam.support@hikvision.com

S-2DE7A432IW-AEB(T5)

MP 32× IR Network Speed Dome

AcuSense

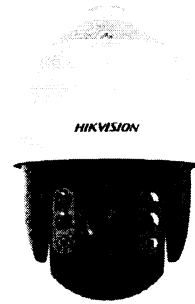
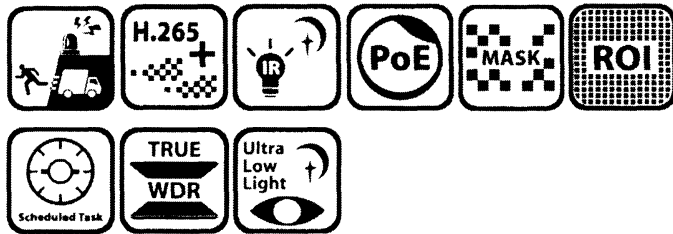

Hikvision DS-2DE7A432IW-AEB(T5) 4 MP 32× IR Network Speed Dome adopts 1/1.8" progressive scan CMOS chip. With the 32× optical zoom lens, the camera offers more details over expansive areas.

This series of cameras can be widely used for wide ranges of high-definition, such as the rivers, roads, railways, airports, squares, parks, scenic spots, and venues, etc.

Empowered by deep learning algorithms, Hikvision AcuSense technology brings human and vehicle targets classification alarms to front- and back-end devices. The system focuses on human and vehicle targets, vastly improving alarm efficiency and effectiveness.

- 1/1.8" progressive scan CMOS
- High quality imaging with 4 MP resolution
- Excellent low-light performance with powered-by-DarkFighter technology
- Audio visual alarm: The white flashing light and audible warning can be triggered by certain events
- 32× optical zoom and 16× digital zoom provide close up views over expansive areas
- Expansive night view with up to 200 m IR distance
- Focuses on human and vehicle targets classification based on deep learning
- Face capture: Up to 5 faces captured at the same time



▪ DORI

The DORI (detect, observe, recognize, identify) distance gives the general idea of the camera ability to distinguish persons or objects within its field of view. It is calculated based on the camera sensor specification and the criteria given by EN 62676-4: 2015.

DORI	Detect	Observe	Recognize	Identify
Definition	25 px/m	63 px/m	125 px/m	250 px/m
Distance (Tele)	2046.9 m (6715.5 ft)	812.3 m (2665.0 ft)	409.4 m (1343.2 ft)	204.7 m (671.6 ft)

▪ Specification

Camera

Max. Resolution	2560 × 1440
Image Sensor	1/1.8" progressive scan CMOS
Min. Illumination	Color: 0.005 Lux @ (F1.5, AGC ON), B/W: 0.001 Lux@(F1.5, AGC ON), 0 Lux with IR
Shutter Speed	1/1 s to 1/30000 s
Slow Shutter	Yes
Day & Night	IR cut filter
Zoom	32x optical, 16x digital

Lens

Focal Length	5.9 mm to 188.8 mm
Zoom Speed	Approx. 4.8 s
FOV	Horizontal field of view: 50.8° to 2.6° (wide-tele), Vertical field of view: 29.4° to 1.5° (wide-tele), Diagonal field of view: 57.4° to 3° (wide-tele)
Aperture	Max. F1.5
Focus	Auto, semi-auto, manual, rapid focus

Illuminator

Supplement Light Type	IR
Supplement Light Range	IR Distance: up to 200 m

PTZ

Movement Range (Pan)	360°
Movement Range (Tilt)	-15° to 90° (auto flip)
Pan Speed	Pan speed: configurable from 0.1° to 160°/s; preset speed: 240°/s
Tilt Speed	Tilt speed: configurable from 0.1° to 120°/s, preset speed 200°/s
Proportional Pan	Yes
Presets	300
Patrol Scan	8 patrols, up to 32 presets for each patrol
Pattern Scan	4 pattern scans
Power-off Memory	Yes
Park Action	Preset, pattern scan, auto scan, tilt scan, random scan, frame scan, panorama scan
3D Positioning	Yes
PTZ Status Display	Yes
Preset Freezing	Yes
Scheduled Task	Preset, pattern scan, patrol scan, auto scan, tilt scan, random scan, frame scan, panorama scan, dome reboot, dome adjust, aux output

Handwritten signatures and initials:
 JJ
 [Signature]
 [Signature]

Video

Main Stream	50 Hz: 25 fps (2560 × 1440, 1920 × 1080, 1280 × 960, 1280 × 720); 60 Hz: 30 fps (2560 × 1440, 1920 × 1080, 1280 × 960, 1280 × 720)
Sub-Stream	50 Hz: 25 fps (704 × 576, 640 × 480, 352 × 288); 60 Hz: 30 fps (704 × 480, 640 × 480, 352 × 240)
Third Stream	50 Hz: 25 fps (1920 × 1080, 1280 × 960, 1280 × 720, 704 × 576, 640 × 480, 352 × 288); 60 Hz: 30 fps (1920 × 1080, 1280 × 960, 1280 × 720, 704 × 480, 640 × 480, 352 × 240)
Video Compression	Main stream: H.265+/H.265/H.264+/H.264 Sub-stream: H.265/H.264/MJPEG Third stream: H.265/H.264/MJPEG
Video Bit Rate	32 kbps to 16384 kbps
H.264 Type	Baseline Profile/Main Profile/High Profile
H.265 Type	Main Profile
Scalable Video Coding (SVC)	H.264 and H.265 encoding
Region of Interest (ROI)	8 fixed regions for each stream

Audio

Audio Compression	G.711alaw, G.711ulaw, G.722.1, G.726, MP2L2, AAC, PCM
Audio Bit Rate	64 Kbps (G.711)/16 Kbps (G.722.1)/16 Kbps (G.726)/32-192 Kbps (MP2L2)/16-64 Kbps (AAC)
Audio Sampling Rate	8 kHz/16 kHz/32 kHz/48 kHz
Environment Noise Filtering	Yes

Network

Network Storage	NAS (NFS, SMB/CIFS), auto network replenishment (ANR)
Protocols	IPv4/IPv6, HTTP, HTTPS, 802.1x, QoS, FTP, SMTP, UPnP, SNMP, DNS, DDNS, NTP, RTSP, RTCP, RTP, TCP/IP, UDP, IGMP, ICMP, DHCP, PPPoE, Bonjour, Websocket, Websockets
API	Open Network Video Interface (Version 19.12, Profile S, Profile G, Profile T), ISAPI, SDK, ISUP
Simultaneous Live View	Up to 20 channels
User/Host	Up to 32 users, 3 user levels: administrator, operator, and user
Security	Password protection, complicated password, HTTPS encryption, 802.1X authentication (EAP-TLS, EAP-LEAP, EAP-MD5), watermark, IP address filter, basic and digest authentication for HTTP/HTTPS, RTP/RTSP over HTTPS, control timeout settings, security audit log, TLS 1.2, TLS 1.3, host authentication (MAC address)
Client	iVMS-4200, HikCentral Pro, Hik-Connect
Web Browser	IE11, Chrome 57+, Firefox 52+, Safari 11+

Image

Day/Night Switch	Day, Night, Auto, Schedule
Image Enhancement	BLC, HLC, 3D DNR
Wide Dynamic Range (WDR)	120 dB
Defog	Digital defog
Image Stabilization	EIS
Regional Exposure	Yes
Regional Focus	Yes
Image Settings	Saturation, brightness, contrast, sharpness, gain, and white balance adjustable by client software or web browser

[Handwritten signatures and initials]

Privacy Mask	24 programmable polygon privacy masks, mask color or mosaic configurable
SNR	> 52 dB
Interface	
Ethernet Interface	1 RJ45 10M/100M self-adaptive Ethernet port
On-board Storage	Built-in memory card slot, support microSD/SDHC/SDXC card, up to 256 GB
Alarm	2 inputs, 1 output
Audio	1 input (line in), max. input amplitude: 2-2.4 vpp, input impedance: 1 kΩ ± 10%; 1 output (line out), line level, output impedance: 600 Ω
Reset	Yes
Built-in Speaker	1 built-in speaker with effective distance reaching max. 30 meters
Event	
Basic Event	Motion detection, video tampering alarm, exception, alarm input and output
Smart Event	Line crossing detection, intrusion detection, region entrance detection, region exiting detection, unattended baggage detection, object removal detection, audio exception detection
Smart Tracking	Manual tracking, auto-tracking
Alarm Linkage	Upload to FTP/NAS/memory card, notify surveillance center, send email, trigger alarm output, trigger recording, audible warning, white light flashing, and PTZ actions (such as preset, patrol scan, pattern scan)
Deep Learning Function	
	Detects up to 5 faces simultaneously.
Face Capture	Supports detecting, capturing, grading, selecting of face in motion, and output the best face picture of the face
Perimeter Protection	Line crossing, intrusion, region entrance, region exiting Support alarm triggering by specified target types (human and vehicle)
General	
Power	24 VAC, max. 42 W (including max. 18 W for IR and max. 10 W for heater); Hi-PoE
Operating Condition	-30 °C to 65 °C (-22 °F to 149 °F). Humidity 90% or less (non-condensing)
Demist	Yes
Material	ADC12
Dimension	Ø 220 mm × 363.3 mm (Ø 8.66" × 13.91")
Weight	Approx. 5 kg (11.03 lb.)
Approval	
Protection	IP66 (IEC 60529-2013), IK10 (excluding glass window), TVS 6000V lightning protection, surge protection and voltage transient protection FCC SDoC (47 CFR Part 15, Subpart B); CE-EMC (EN 55032: 2015, EN 61000-3-2: 2019, EN 61000-3-3: 2013, EN 50130-4: 2011
EMC	+A1: 2014); RCM (AS/NZS CISPR 32: 2015); IC VoC (ICES-003: Issue 6, 2019); KC (KN 32: 2015, KN 35: 2015)

Handwritten signature

Handwritten signature

Safety	UL (UL 62368-1); CB (IEC 60950-1:2005 + Am 1:2009 + Am 2:2013, IEC 62368-1:2014); CE-LVD (EN 62368-1:2014+A11:2017); BIS (IS 13252(Part 1):2010+A1:2013+A2:2015); LOA (SANS IEC60950-1)
Environment	CE-RoHS (2011/65/EU); WEEE (2012/19/EU); Reach (Regulation (EC) No 1907/2006)

▪ **Available Model**

DS-2DE7A432IW-AEB(T5)

▪ **Typical Application**

Hikvision products are classified into three levels according to their anti-corrosion performance. Refer to the following description to choose for your using environment.

This model has NO SPECIFIC PROTECTION.

Level	Description
Top-level protection	Hikvision products at this level are equipped for use in areas where professional anti-corrosion protection is a must. Typical application scenarios include coastlines, docks, chemical plants, and more.
Moderate protection	Hikvision products at this level are equipped for use in areas with moderate anti-corrosion demands. Typical application scenarios include coastal areas about 2 kilometers (1.24 miles) away from coastlines, as well as areas affected by acid rain.
No specific protection	Hikvision products at this level are equipped for use in areas where no specific anti-corrosion protection is needed.

[Handwritten signatures and initials]

▪ Dimension

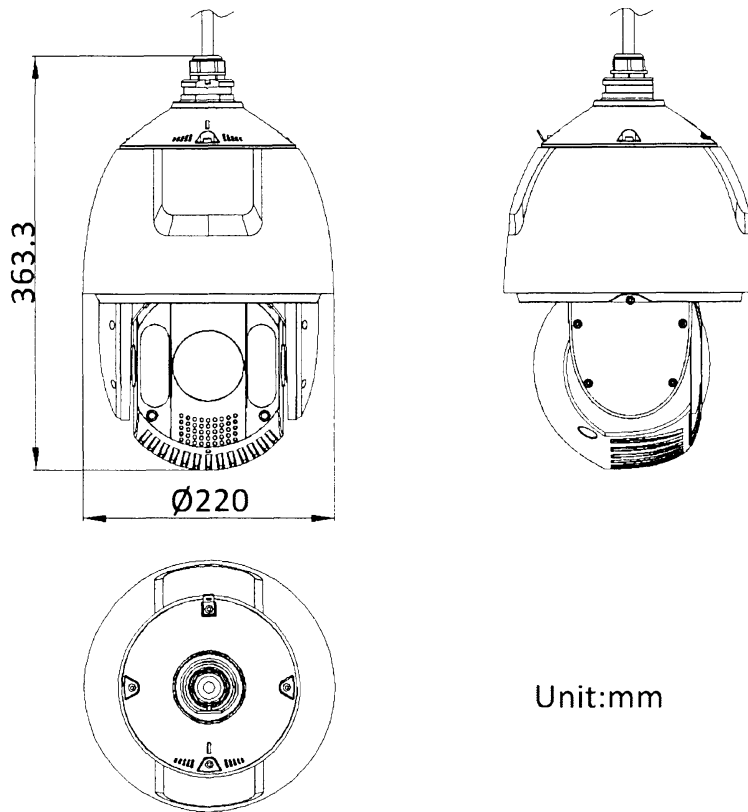

▪ Accessory

▪ Included

DS-1602ZJ
Wall mount

▪ Optional

DS-1619ZJ

DS-1662ZJ

DS-1660ZJ

DS-1661ZJ

DS-1673ZJ



Handwritten signatures and marks, including 'Bolle' and other illegible scribbles.

**DS-1604ZJ-BOX-
CORNER**



DS-1604ZJ-box



**DS-1604ZJ-BOX-
POLE**



DS-1681ZJ



DS-1682ZJ

DS-1667ZJ

DS-1663ZJ

DS-1604ZJ



AC

**DS-1673ZJ should be used with DS-1661ZJ or DS-1662ZJ.*

[Handwritten signature]

[Handwritten signature]
[Handwritten signature]

Distributed by



HIKVISION

Headquarters

No.555 Qianmo Road, Binjiang District,
Hangzhou 310051, China
T +86-571-8607-5936
overseasbusiness@hikvision.com

Hikvision USA
T +1-909-835-0400
sales.usa@hikvision.com

Hikvision Australia
T +61-2-8599-4233
salesau@hikvision.com

Hikvision India
T +91-22-26469900
sales@pramatihikvision.com

Hikvision Canada
T +1-866-200-6600
sales.canada@hikvision.com

Hikvision Thailand
T +662-275-0949
sales.thailand@hikvision.com

Hikvision Europe
T +31-23-5542770
sales.eu@hikvision.com

Hikvision Italy
T +39-0438-69002
info.it@hikvision.com

Hikvision Brazil
T +55-11-3318-0050
latam.support@hikvision.com

Hikvision Turkey
T +90 (216) 21 7070-7074
sales.tr@hikvision.com

Hikvision Malaysia
T +601-7652-2413
sales.my@hikvision.com

Hikvision UK & Ireland
T +01628-502140
sales.uk@hikvision.com

Hikvision South Africa
Tel: +27 (10) 0551172
sales.africa@hikvision.com

Hikvision France
T +33(0)1-85-530-450
info.fr@hikvision.com

Hikvision Kazakhstan
T +7-727-8750067
niklapantilov@hikvision.ru

Hikvision Vietnam
T +84-976278888
sales.vt@hikvision.com

Hikvision UAE
T +971-4-4432090
salesna@hikvision.com

Hikvision Singapore
T +65-6884-4716
sg@hikvision.com

Hikvision Spain
T +34-91-737-16-55
info.es@hikvision.com

Hikvision Tashkent
T +99-97-1235-8436
uzb@hikvision.ru

Hikvision Hong Kong
T +852-2151-1761
info.hk@hikvision.com

Hikvision Russia
T +7-495-669-07-99
sales.ru@hikvision.com

Hikvision Korea
T +82-10131-731-8817
sales.korea@hikvision.com

Hikvision Poland
T +48-22-460-01-50
info.pl@hikvision.com

Hikvision Indonesia
T +62-21-2532757
Sales.indonesia@hikvision.com

Hikvision Colombia
sales.colombia@hikvision.com

DS-1100KI(C) Network Keyboard

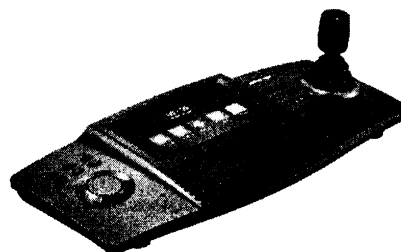

DS-1100KI(C) is a new generation network keyboard independently developed by Hikvision. It features a 7-inch LCD touch screen and a 4-axis joystick. It supports network access to DVRs, DVSs, NVRs, network cameras, network domes, multi-functional video centers (MVCs), decoders, iSecure, and HikCentral and supports analog matrix and analog dome access, with powerful functions and quick and simple operations. It can be widely used in finance, telecommunication, transportation, electric power, education, water conservancy, and other fields.

- Supports video wall division by areas
- Supports window opening/closing, window movement, window scaling, window division, sub-window scaling and other operations
- Supports group operation, macro operation and other batch operations
- Supports the real-time preview of the camera image via the keyboard
- Supports switching the camera location ID by using the PREV button and NEXT button on the keyboard
- Supports PTZ direction control via the 4-axis joystick
- Supports decoder playback via the video wall
- Supports the playback of the DVR and NVR video files via the keyboard and supports the picture capturing and clipping
- Supports device access via the SDK and ONVIF standard protocols
- Accessible to iSecure and HikCentral
- Allows 32 users (1 administrator and 31 operators) to manage a maximum of 4000 devices
- Supports adding, modifying, and deleting the camera locations in batches
- Supports import/export of configuration files

Specification

	Model	DS-1100KI(C)
Device Parameter	Display	7 inch LCD
	Control Method	Network method, serial control
	Power Supply	12 VDC
	Consumption	≤ 15 W
	Dimension	435 mm × 193 mm × 110 mm (17.13 inch × 7.60 inch × 4.33 inch) (L × W × H)
Decoding Parameter	Weight	2 kg (4.41 lb.)
	Compatible System	Linux system
Environmental Parameter	Performance	4 × 1080p
	Working Temperature	-10 °C to 55 °C (14°F to 131°F)
External Interface	Working Humidity	10% to 90%
	Network	RJ45 100 M/1000 M self-adaptive Ethernet interface × 1
	Wi-Fi	Not supported
	Serial Port	RS-485, RS-422
	Two-Way Audio Input	3.5 mm stereo, supporting the audio communication
	Two-Way Audio Output	3.5 mm stereo, supporting the audio communication
	Joystick	4-axis single button joystick
	USB Interface	USB 2.0 × 1

Typical Application

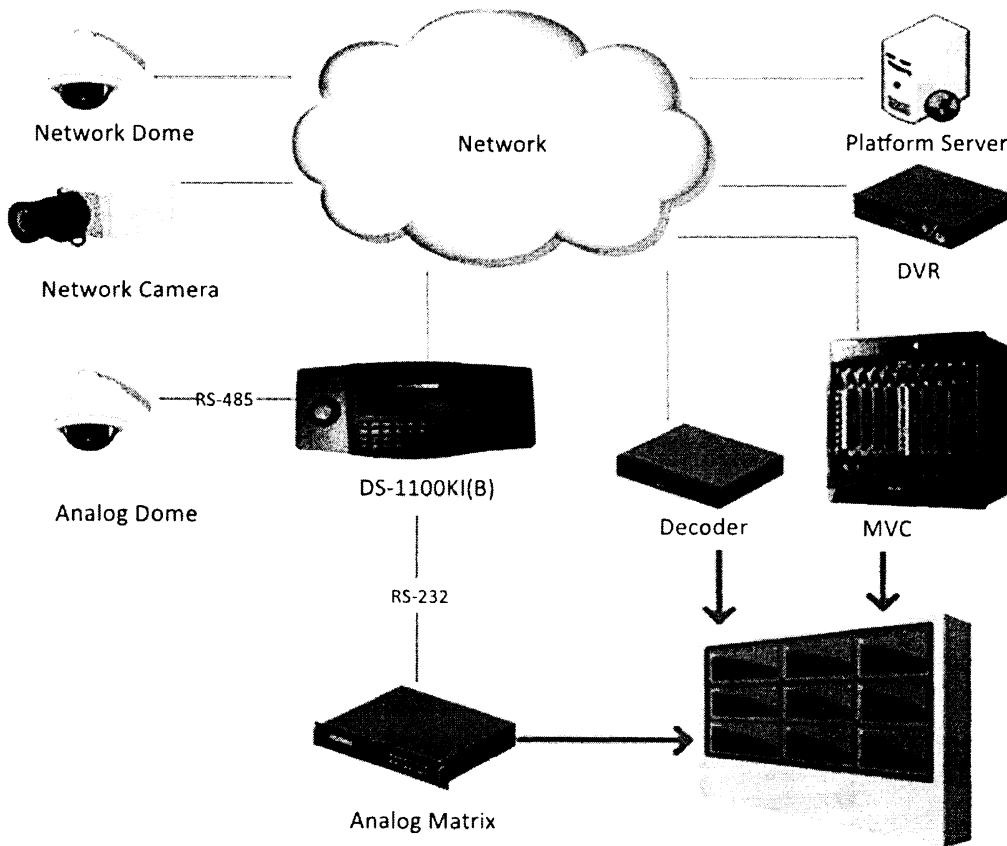

Headquarters
 No.555 Qianmo Road, Binjiang District,
 Hangzhou 310051, China
 T: +86 571 8207 8888
www.hikvision.com

Head Office: www.hikvision.com to get the latest product and service information.

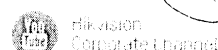

Handwritten signatures and scribbles, including a large stylized signature and a QR code.

▪ Available Model

DS-1100KI(C)

Headquarters

No.555 Qianmo Road, Binjiang District,
Hangzhou 310051, China
T: +86 571 8207 5908
www.hikvision.com

For more social media to get the latest product and solution information



Hikvision



HikvisionHQ



HikvisionHQ



Hikvision_Global



Hikvision
Corporate Channel



HikvisionHQ



Handwritten signature

DS-7708NXI-K4/8P

8-ch 1.5U 8 PoE K Series AcuSense 4K NVR

Key Feature

- Up to 8-ch IP camera inputs, plug & play with 16 power-over-Ethernet (PoE) interfaces
- H.265+/H.265/H.264+/H.264 video formats
- Up to 2-ch@12 MP or 3-ch@8 MP or 6-ch@4 MP or 12-ch@1080p decoding capacity
- Up to 80 Mbps incoming bandwidth
- Adopt Hikvision Acusense technology to minimize manual effort and security costs

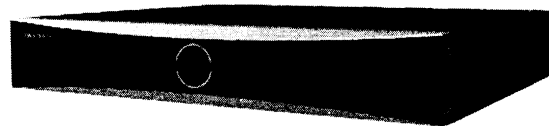

Smart Function

- All channels support Motion Detection 2.0
- 2-ch video analysis for human and vehicle recognition to reduce false alarm
- 1-ch facial recognition for video stream, or 4-ch facial recognition for face picture
- Smart search for the selected area in the video, and smart playback to improve the playback efficiency

Professional and Reliability

- H.265+ compression effectively reduces the storage space by up to 75%
- Adopt stream over TLS encryption technology which provides more secure stream transmission service

HD Video Output

- Provide independent HDMI and VGA outputs
- HDMI video output at up to 4K resolution

Storage and Playback

- Up to 4 SATA interfaces for HDD connection (up to 10 TB capacity per HDD)
- 8-ch synchronous playback

Network & Ethernet Access

- 8 independent PoE network interfaces
- 1 self-adaptive 10/100/1000 Mbps Ethernet interface
- Hik-Connect for easy network management

▪ Specification

Intelligent Analytics

AI by Device	Facial recognition, perimeter protection, motion detection 2.0
AI by Camera	Facial recognition, perimeter protection, throwing objects from building, motion detection 2.0, ANPR, VCA

Facial Recognition

Facial Detection and Analytics	Face picture comparison, human face capture, face picture search
Face Picture Library	Up to 16 face picture libraries, with up to 20,000 face pictures in total (each picture ≤ 4 MB, total capacity ≤ 1 GB)
Facial Detection and Analytics Performance	1-ch, 8 MP
Face Picture Comparison	4-ch

Motion Detection 2.0

By Device	All channels, up to 4 MP (when enhanced SVC mode is enabled, up to 8 MP) video analysis for human and vehicle recognition to reduce false alarm
By Camera	All channels

Perimeter Protection

By Device	2-ch, 4 MP (HD network camera, H.264/H.265) video analysis for human and vehicle recognition to reduce false alarm
By Camera	All channels

Video and Audio

IP Video Input	8-ch
Incoming Bandwidth	80 Mbps
Outgoing Bandwidth	160 Mbps
HDMI Output	1-ch, 4K (3840 × 2160)/30Hz, 2K (2560 × 1440)/60Hz, 1920 × 1080/60Hz, 1600 × 1200/60Hz, 1280 × 1024/60Hz, 1280 × 720/60Hz, 1024 × 768/60Hz
VGA Output	1-ch, 1920 × 1080/60Hz, 1280 × 1024/60Hz, 1280 × 720/60Hz
Video Output Mode	HDMI/VGA independent output
CVBS Output	N/A
Audio Output	1-ch, RCA (Linear, 1 KΩ)
Two-Way Audio	1-ch, RCA (2.0 Vp-p, 1 KΩ, using the audio input)

Decoding

Decoding Format	H.265/H.265+/H.264+/H.264
Recording Resolution	12 MP/8 MP/6 MP/5 MP/4 MP/3 MP/1080p/UXGA/720p/VGA/4CIF/DCIF/2CIF/CIF/QCIF
Synchronous playback	8-ch

(Handwritten signatures and marks)

Decoding Capability	AI on: 1-ch@12 MP (30 fps)/2-ch@8 MP (30 fps)/4-ch@4 MP (30 fps)/8-ch@1080p (30 fps) AI off: 2-ch@12 MP (30 fps)/3-ch@8 MP (30 fps)/6-ch@4 MP (30 fps)/12-ch@1080p (30 fps)
Stream Type	Video, Video & Audio
Audio Compression	G.711ulaw/G.711alaw/G.722/G.726/AAC
Network	
Remote Connection	128
API	ONVIF (profile S/G); SDK; ISAPI
Compatible Browser	IE11, Chrome V57, Firefox V52, Safari V12, Edge V89, or above version
Network Protocol	TCP/IP, DHCP, IPv4, IPv6, DNS, DDNS, NTP, RTSP, SADP, SMTP, SNMP, NFS, iSCSI, ISUP, UPnP™, HTTP, HTTPS
Network Interface	1 RJ-45 10/100/1000 Mbps self-adaptive Ethernet interface
PoE	
Interface	8
Power	≤ 150 W
Standard	IEEE 802.3af/at
Auxiliary Interface	
SATA	4 SATA interfaces
Capacity	Up to 10 TB capacity for each HDD
Serial Interface	2 RS-485 (half-duplex), 1 RS-232
Alarm In/Out	16/4 (16/9 is optional)
USB Interface	Front panel: 2 × USB 2.0; Rear panel: 1 × USB 3.0
Ctrl 12V	N/A (optional to support)
DC 12V	N/A (optional to support)
General	
GUI Language	English, Russian, Bulgarian, Hungarian, Greek, German, Italian, Czech, Slovak, French, Polish, Dutch, Portuguese, Spanish, Romanian, Turkish, Japanese, Danish, Swedish, Norwegian, Finnish, Korean, Traditional Chinese, Thai, Estonian, Vietnamese, Croatian, Slovenian, Serbian, Latvian, Lithuanian, Uzbek, Kazakh, Arabic, Ukrainian, Kyrgyz, Brazilian Portuguese, Indonesian
Power Supply	100 to 240 VAC, 50 to 60Hz, 75W
Consumption	≤ 20 W (without HDD and PoE off)
Working Temperature	-10 °C to 55 °C (14 °F to 131 °F)
Working Humidity	10 to 90 %
Dimension (W × D × H)	445 × 400 × 75 mm (17.5"× 15.7" × 3.0")

Weight	≤ 5 kg (without HDD, 11 lb.)
Certification	
FCC	Part 15 Subpart B, ANSI C63.4-2014
CE	EN 55032: 2015, EN 61000-3-2, EN 61000-3-3, EN 50130-4, EN 55035: 2017
Obtained Certification	CE, FCC, IC, CB, KC, UL, Rohs, Reach, WEEE, RCM, UKCA, LOA, BIS

Note:

- Alarm in/out can be optional for certain models. If you select a device model with "/Alarm16+9", then the device will have 16 alarm inputs and 9 alarm outputs.
- Facial recognition, motion detection 2.0 or perimeter protection cannot be enabled at the same time.

Dimension

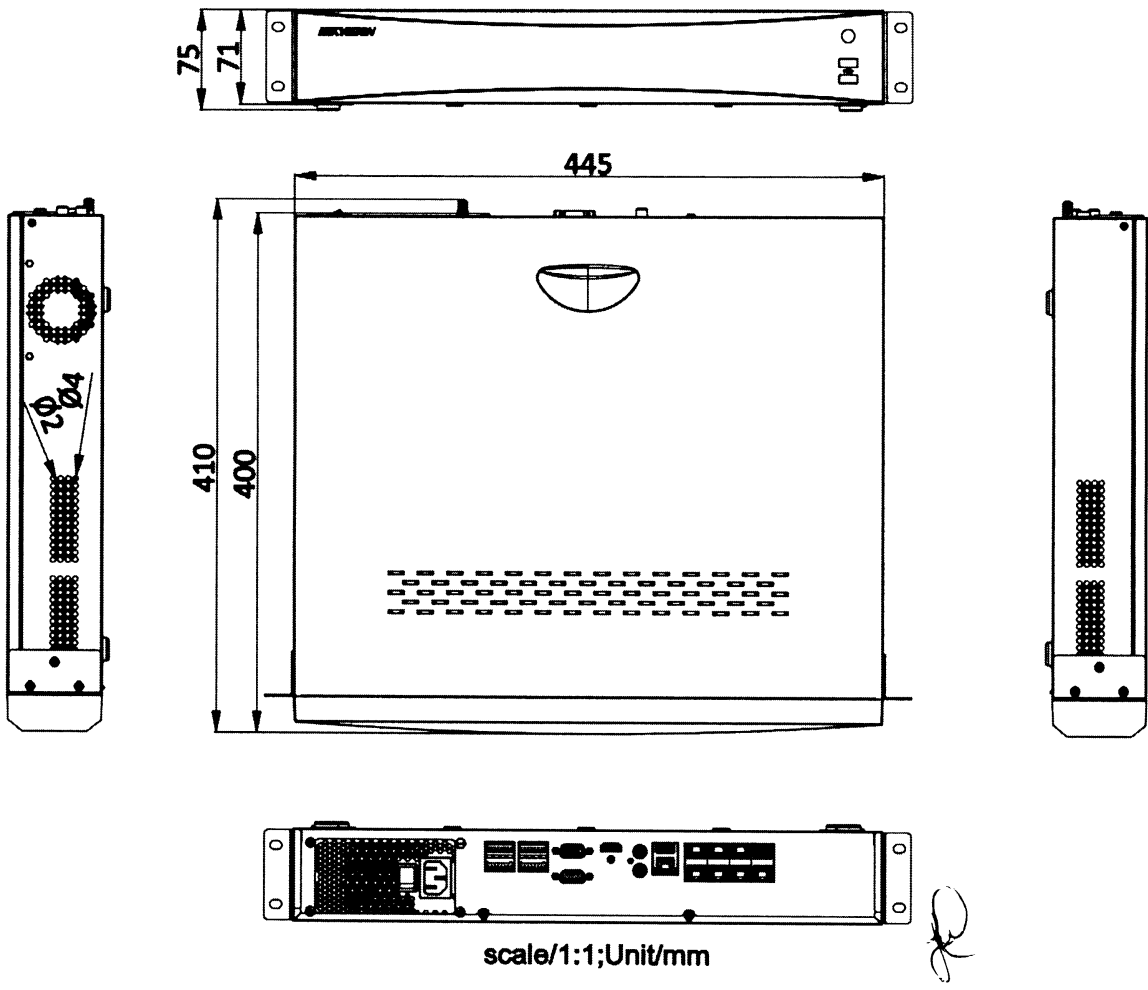

Handwritten notes and signatures:

- A large handwritten signature or mark on the right side.
- Handwritten initials "B" and "B" with arrows pointing to specific areas.
- Handwritten text "B. on leave" with an arrow pointing to a specific area.
- Handwritten text "C" and "D" with arrows pointing to specific areas.

Physical Interface

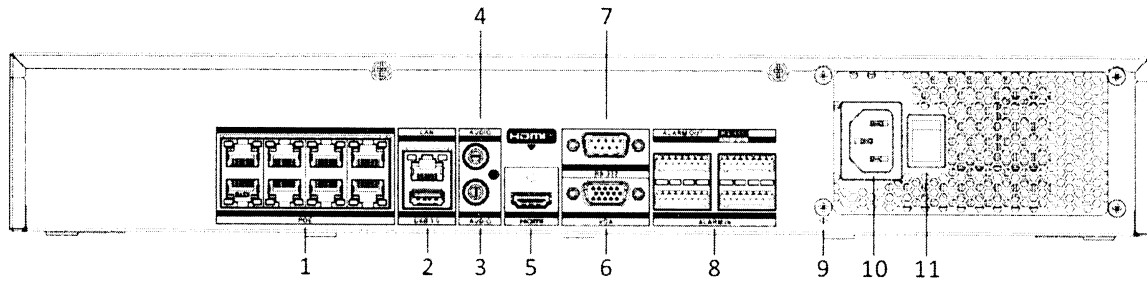

No.	Description	No.	Description
1	Network interfaces with PoE function	7	RS-232 serial interface
2	USB 3.0 interface and LAN interface	8	Alarm in, alarm out and RS-485
3	Audio out	9	GND
4	Audio in	10	Power supply
5	HDMI interface	11	Power switch
6	VGA interface		

Available Model

DS-7708NXI-K4/8P

Handwritten signature

Headquarters
 No.535 Dianmo Road, Binjiang District,
 Hangzhou, 310051, China
 T: +86-571-8907-5938
 www.hikvision.com

Follow us on social media to get the latest product and solution information



Handwritten signature

HikCentral Professional

HikCentral Professional is a software platform provided by Hikvision for integrating and managing security systems. It is designed to meet a variety of security challenges on a single platform. With HikCentral Professional, you can manage multiple individual systems with ease, such as video security, access control, security alarms, and more, as well as explore cross-system functionalities.

Daily operations become more efficient while protection of people and property improve all around. Users of all kinds are making smarter decisions.

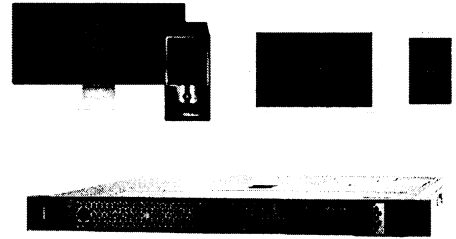

Key Feature

Light and Efficient

- Lightweight architecture features reduced consumption of system resources
- Capable of managing multiple systems of varying sizes with consistent efficiency

Unified and Flexible

- Supports combining various application plug-ins under a unified, on-demand architecture for collaboration across business segments
- New plug-ins can be continuously developed to meet new business needs

Integrated and Open

- Compatible with virtually all Hikvision products and their abundance of applications, including deep-learning-based analytics and statistics
- Open architecture permits easy integration with third-party systems and hardware

A handwritten signature or mark.

A collection of handwritten signatures and marks.

• Features of Main Modules

Module	Features
Video	<ul style="list-style-type: none"> ● Efficient and comprehensive video security ● Quick incident search and location, convenient event search, and quick run-through of video ● Video export as evidence ● Low bandwidth network adaptability ● Reliable and flexible storage
Access Control	<ul style="list-style-type: none"> ● Comprehensive and flexible access management methods ● Advanced access strategies for sensitive areas ● Convenient employee badge design and printing ● Clear step-by-step guidance ● Remote personnel registration ● Automatically lock or unlock doors ● Keep doors in a remain unlocked status during an emergency ● Easily count and verify everyone's safety ● Opening door via Bluetooth and NFC
Visitor	<ul style="list-style-type: none"> ● Digitalized visitor management ● Visitor registration in advance ● Pre-defined access permissions and traceable records ● A Watchlist function along with personalized design and printing of badges
Vehicle	<ul style="list-style-type: none"> ● Flexible and efficient entrance & exit management ● Improved parking experience for drivers ● Self-service parking query ● Flexible billing ● Intuitive and efficient parking operation analysis and transaction analysis reports
On-Board Monitoring	<ul style="list-style-type: none"> ● Efficient vehicle monitoring for quick response ● Reliable archive management ● Customized reports for enhanced operational efficiency
Alarm Detection	<ul style="list-style-type: none"> ● Centrally manage various alarm sources ● Real-time display of all kinds of alarms ● Flexible linkage ● Automatic audio alarms
Intelligent Analysis	<ul style="list-style-type: none"> ● The video-based intelligent analysis dashboard enables flexible and extensible digital applications ● Smart commercial analyses
Digital Signage	<ul style="list-style-type: none"> ● Manage and configure content for digital signage in an intuitive manner ● Pre-installed program templates ● All programs are created visually
Time & Attendance	<ul style="list-style-type: none"> ● Flexible attendance rule-setting ● Diverse attendance reports and customizable templates ● Easy integration with third-party payroll systems ● Supports employees searching for attendance results and submitting applications for correction
Maintenance	<ul style="list-style-type: none"> ● Visualized network and device topology and alarm notifications ● Logs are available for event trackback and evidence

R

[Signature]

[Signature]
[Signature]

Software Specification

The following table shows the maximum performance of the SYS (System Management Server). For other detailed data and performance, refer to *Software Requirements and Performance*.

Features		Maximum Performance	
General			
General	Managed Devices <i>*Including Encoding Devices, Access Control Devices, Elevator Control Devices, Security Control Devices, Digital Signage Terminals, Interactive Flat Panels, Remote Sites, Guidance Terminals, and IP Speakers</i>	2,048	
	Encoding Devices Supporting ONVIF Protocol	2,048	
	Video Intercom Devices	5,000	
	Guidance Screens	512	
	Visitor Terminals	32	
	Dock Stations	1,500	
	Network Transmission Devices	128	
	On-Board Devices	1,000	
	Fire Protection Devices	2,048	
	Entrance/Exit Stations	40	
	Query Terminals	16	
	DeepinMind Server	64	
	Recording Servers	64	
	Streaming Servers	64	
	Manageable Resource	Cameras	10,000 With RSM: 100,000
		Maximum Number of Fisheye Cameras	10,000
		Maximum Number of Cameras for People Counting	
Alarm Inputs (excluding security control panels and panic alarm devices)		5,000	
Alarm Inputs of Security Control Devices		10,000	
Security Control Partitions (Areas)		2,048	
Alarm Outputs		3,000	
Security Radars and Radar PTZ Cameras		30	
DS-5600 Series Face Recognition Terminals When Applied with Hikvision Turnstiles		32	
ANPR Cameras		3,000	
People Counting Cameras		Recommended: 3,000	
Heat Map Cameras		Recommended: 1,024	
Queue Management Cameras		Recommended: 3,000	
Thermal Cameras		Recommended: 20 ^①	
Event & Alarm		Cameras per Area	256
	Alarm Inputs per Area		
	Alarm Outputs per Area		
Event & Alarm	Event and Alarm Rules	10,000	
	Storage of Events or Alarms Without Pictures	1,000/s	
	Storage of Events or Alarms with Pictures	20/s (Stored in SYS) 80/s (Stored in Recording Server)	
	Events or Alarms Sent to Clients <i>*The clients include Web Client, Control Clients and Mobile Clients.</i>	<ul style="list-style-type: none"> ● Web Client: 20 events or alarms with picture per second; 40 events or alarms without picture per second; 100 access events/s. ● Control Client: 120 events or 	

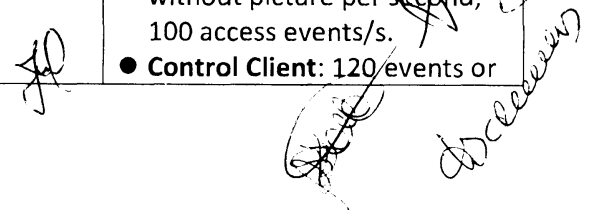

		alarm/s. ● 100 Clients/s
	Combined Alarm	10/s
	User-Defined Events	10,000
User and Role	Concurrent Accesses via Web Clients and Control Clients	100
	Concurrent Accesses via Mobile Clients	100
	Users	3,000
	Roles	3,000
	Users for Double Authentications	50
Person	Departments	3,000
	Department Hierarchies	10
	Size of a Profile Picture	300 KB
	Total Size of Profile Pictures	300 GB
	Resigned Persons	100,000
	Resignation Types	100
Data Storage	Data Retention Period	Stored for 3 Years
	People Counting	5 million each year
	Heat Map	0.25 million each year
	ANPR Records	
	Events	60 million each year
	Alarms	
	Access Records	1.4 billion each year
	Attendance Records	55 million each year
	Visitor Records	10 million each year
	Operation Logs	
	Service Information Logs	5 million each year
	Service Error Logs	
Report	Recording Tags	60 million each year
	Scheduled Report Rules of Event and Alarm	100
	Event or Alarm Rules in One Event/Alarm Report Rule	32
	Records in One Sent Report	10,000 or 10 MB
	Resources Selected in One Report <i>*With this limitation, you can generate a neat and clear report via the Control Client and it costs less time.</i>	32
	Maximum Number of Stores	1,000
Video & Intelligent Analysis		
Recording	Recording Schedule	30,000
	Recording Schedule Template	200
Face Comparison	Face Pictures for Comparison	1,000,000
	Face Comparison Groups	64
	Persons in One Face Comparison Group	1,000,000
	Storage of Face Comparison Events Without Pictures	1,000/s
	Storage of Face Comparison Events with Pictures	100/s (Stored in Recording Server)
Intelligent Recognition	Intelligent Analysis Groups	1,000
	Resources in One Group	64
	Persons for Intelligent Recognition	1000,000
BI	Total Stores	1,000
	Total Analysis Group	1000
AR Monitoring	AR Scenes	100
	Plans	512 <i>Note: Up to 100 scenes are allowed for each plan.</i>
	Tags for Each Scene	200
	Tag Groups for Each Scene	100
Evidence Management	Evidences	100,000

①

②

③

④

	Evidence Files	5,000,000
Smart Wall	Decoding Devices	32
	Smart Walls	32
	Network Keyboard	8
	Views	1,000
	View Groups	100
	Views in One View Group	10
	Cameras in One View	256
	Cameras in One Window of Auto-Switch	20
	Windows of an Auto-Switch	16
	View Group of an Auto-Switch	1
Streaming Server	Video Input Bandwidth per Streaming Server	200 × 2 Mbps
	Video Output Bandwidth per Streaming Server	200 × 2 Mbps
Access Control & Time and Attendance & Visitor		
Access Control	Persons with Credentials for Access Control	50,000
	Total Credentials (Card + Fingerprint)	250,000
	Cards	250,000
	Fingerprints	200,000
	Irises	100,000
	Profiles	50,000
	Access Points (Doors + Floors)	1,024
	Access Levels	512
	Access Schedules	32
	Templates for Card Printing	32
Time and Attendance	Persons for Time and Attendance	50,000
	Schedules	128
	Holidays	32
	Break Timetable	128
	Custom Rules for T&A Status on Device	128
	Overtime Types	128
	Leave Types	
	Approval Roles	100
	Approval Flows	1,000
	Concurrent Login of Employees via Client	500
Visitor Management	Visitors	100,000
	Visitor Check-In or Reservation Records	100,000
	Visitor Email Templates	20
	Entities in Watch List	10,000
	Card Template	20
Vehicle and Parking Management		
	Vehicles per List	5,000
	Vehicles	500,000
	Custom Vehicle Types	10
	UVSSs	4
	Vehicle Undercarriage Pictures	3,000
	Storage of ANPR Alarm Without Pictures	1,000/s
	Storage of ANPR Alarm with Picture	20/s (Stored in SYS) 100/s (Stored in Recording Server)
	Parking Lots	10
	Lanes	Total: 40 In One Parking Lot: 32
	Parking Spaces	Total: 3,000 In One Floor: 1,024
	Floors in All Parking Lots	128
	Cards Linked with Vehicles	250,000
	Temporary Cards in One Parking Lot	10,000

(Handwritten mark)

(Handwritten mark)

(Handwritten signature)

(Handwritten signature)

Vehicle Passing Frequency in Each Lane	1 Vehicle/s
On-Board Monitoring	
Fence Rules for One Vehicle	4
Vehicles Can Be Located in One Client	64
Retention Period of GPS Data	1 Year
Retention Period of Statistics Data	3 Years
Maximum Number of Drivers	10,000
Maximum Number of Driving Routes	1,000
Digital Signage	
Materials	10,000
Programs	2,000
Schedules	1,000
Release Records	1,000
Video Walls	512
Applications for Interactive Flat Panel	1,000
Security Inspection	
Analyzers	8
Walk-Through Metal Detectors	64
Security Inspection Channels	1,000
Broadcast	
IP Speakers	2048
Speaker Unit	128
Broadcast Group	128
Media Libraries	100
Patrol	
Maximum Number of Shifts of a Single Route	8

①: This recommended value refers to the number of thermal cameras connected to the system directly. It depends on the maximum performance (data processing and storage) in the situation when the managed thermal cameras uploading temperature data to the system. For thermal cameras connected to the system via NVR, there is no such limitation.

A

F

A
B
2022/11/20

System Requirement

* For high stability and good performance, the following system requirements must be met.

OS for HikCentral Professional Server	Microsoft® Windows 11 64-bit Microsoft® Windows 10 64-bit Microsoft® Windows 8.1 64-bit Microsoft® Windows 7 SP1 64-bit Microsoft® Windows Server 2019 64-bit Microsoft® Windows Server 2016 64-bit Microsoft® Windows Server 2012 R2 64-bit Microsoft® Windows Server 2012 64-bit Microsoft® Windows Server 2008 R2 SP1 64-bit Microsoft® Windows Server 2022 *For Windows 8.1 and Windows Server 2012 R2, make sure it is installed with the rollup (KB2919355) updated in April, 2014.
OS for Control Client	Microsoft® Windows 11 64-bit Microsoft® Windows 10 64-bit Microsoft® Windows 8.1 64-bit Microsoft® Windows 7 SP1 64-bit Microsoft® Windows Server 2019 64-bit Microsoft® Windows Server 2016 64-bit Microsoft® Windows Server 2012 R2 64-bit Microsoft® Windows Server 2012 64-bit Microsoft® Windows Server 2008 R2 SP1 64-bit *For Windows 8.1 and Windows Server 2012 R2, make sure it is installed with the rollup (KB2919355) updated in April, 2014.
Browser Version	Google Chrome® 100 and above Firefox® 100 and above Safari® 13 and above Microsoft® Edge 100 and above Internet Explorer® 11 and above
Database	PostgreSQL V11.8
OS for Mobile Client	iOS 10.0 and above Android 6.0 and above
Virtual Machine	VMware® ESXi™ 6.x, ESXi™ 7.x Microsoft® Hyper-V with Windows Server 2012/2012 R2/2016 (64-bit) *The Control Client cannot run on the virtual machine. *Refer to the Deployment Guide of HikCentral Professional on VMware Virtual Machines for how the streaming server running on the virtual machine. *Virtual server migration is not supported.

Recommended Hardware Specification

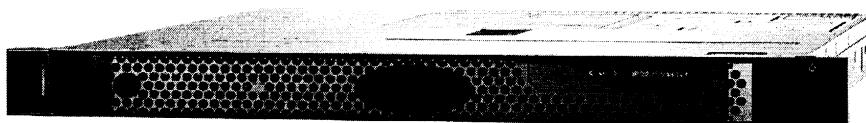

Processor	Intel® Xeon® E-2314 @ 2.80 GHz	
Memory	16G DDR4 DIMM slots, Supports UDIMM, up to 2666 MT/s, 64GB Max. Supports registered ECC	
Storage Controllers	Internal Controllers: SAS_H330 Software RAID: PERC S140 External HBAs: 12Gbps SAS HBA (non-RAID) Boot Optimized Storage Subsystem: 2x M.2 240GB (RAID 1 or No RAID), 1x M.2 240GB (No RAID Only)	
Drive Bays	1T 7.2K SATA×2	
Power Supplies	Single 250W (Bronze) power supply	
Dimensions	Form Factor: Rack (1U) Chassis Width: 434.00mm (17.08 in) Chassis Depth: 595.63mm (23.45 in) (3.5" HDD) <i>Note:</i> These dimensions do not include: bezel, redundant PSU	
Dimensions with Package (W × D × H)	750 mm × 614 mm × 259 mm (29.53" × 24.17" × 10.2")	
Net Weight	12.2 kg	
Weight with Package	18.5 kg	
Embedded NIC	2 x 1GbE LOM Network Interface Controller (NIC) ports	
Device Access	Front Ports: 1x USB 2.0, 1 x iDRAC micro USB 2.0 management port Rear Ports: 2 x USB 3.0, VGA, serial connector	
Embedded Management	iDRAC9 with Lifecycle Controller iDRAC Direct DRAC RESTful API with Redfish	
Integrations and Connections	Integrations: Microsoft® System Center VMware® vCenter™ BMC Truesight (available from BMC) Red Hat Ansible	Connections: Nagios Core & Nagios XI Micro Focus Operations Manager i (OMi) IBM Tivoli Netcool/OMNIBus
Operating Systems	Certify XenServer Citrix® XenServer® Microsoft Windows Server® with Hyper-V <i>Note:</i> This model is installed with Microsoft Windows Server® 2016 multilingual operating system.	
Virtual Machines	VMware® ESXi	

Headquarters

No.555 Qianmo Road, Binjiang District,
Hangzhou 310051, China
T +86-571-8807-5888
www.hikvision.com

Follow us on social media to get the latest product and solution information.



hikvision



hikvisionHQ



hikvisionHQ



Hikvision_Global



Hikvision
Corporate Channel



hikvisionhq



Handwritten signatures and scribbles in the bottom right corner.

ragtech

NOBREAK

SENOIDAL DIGITAL

1400VA
1600VA
2000VA
3200VA



Exclusivo Nobreak Senoidal com características profissionais, acessível também ao usuário doméstico. Incorpora tecnologia true RMS e seleção automática da rede elétrica (True Full Range). Por meio de um microprocessador de alta performance o Easy Pro realiza completo gerenciamento em tempo real, construindo uma onda senoidal pura. Indicado para computadores, desktop ou servidores (com ou sem fontes PFC - correção de fator de potência), estações em rede e pequenos motores.



tecnologia
senoidal



tecnologia
true rms



Destaques



Display digital informa o estado de operação do nobreak e da rede elétrica [exclusivo]



Troca fácil de bateria



Rodízios para fácil movimentação



Guia de cabos organiza os cabos conectados



Expansão de autonomia até 12 horas com módulo adicional [somente modelos Vio e CBu]



Software de gerenciamento gratuito na internet [somente modelos Vio, CBu e USB]



Estabilizador interno correção precisa mesmo em redes sobrecarregadas, com 11 estágios de regulação

Recursos



Tomadas de saída
todas protegidas
na falta de energia.
Conforme NBR 14136



Filtro de linha
contra distúrbios
na rede elétrica



Microprocessado
precisão digital no
controle da energia.



Proteção eficiente
contra subtensão, sobretensão,
sobrecarga, curto-circuito
e sobretemperatura



True full range [trivolt]
seleção automática da rede



Conector de bateria
engate rápido, facilitando a instalação
do módulo de bateria
[somente modelos Vio e CBu]



Gerenciamento de bateria
gerencia a vida útil e
o estado da bateria



Porta USB
compatibilidade, flexibilidade e
praticidade na comunicação
[somente modelos Vio, CBu e USB]



Powerlook [battery save]
reduz consumo de energia de equipamentos
em stand-by [somente modelos Vio, CBu e USB]

Handwritten mark

Handwritten mark

Handwritten signature

Recursos gerais

Recursos

- troca fácil de bateria pelo usuário
- tecnologia senoidal on-line simples conversão de acordo com a norma NBR 15014
- microprocessador FLASH e função true RMS
- seleção automática [true full range] 115V, 127V e 220V [modelo Ti]
- chave liga/desliga temporizada com função MUTE
- 10 (dez) tomadas de saída protegidas contra falta de energia
- display digital, exibe vários parâmetros do nobreak como: tensão, carga de bateria e potência
- powerlook: evita a descarga desnecessária de bateria [battery save] / [só modelos Vio, CBU e USB]
- conector tipo engate rápido para expansão de bateria [somente modelos Vio e CBU]
- DC-start: partida mesmo sem rede elétrica
- Porta USB - software gratuito na internet [somente modelos Vio, CBU e USB]
- guia de cabos
- gerenciamento da vida útil da bateria com autodiagnóstico de baterias
- auto-partida: liga automaticamente o nobreak no retorno da rede

Proteções

- filtro de linha contra distúrbios na rede elétrica
- estabilizador com 11 [onze] estágios de regulação ON-LINE [modelo Ti]
- proteção contra subtensão e sobretensão
- proteção contra potência excedida [sobrecarga], curto-circuito e sobretemperatura
- proteção contra descarga total das baterias
- fusíveis e varistores de ação rápida
- disjuntor na entrada (rearme automático)

Traseira do Modelo Easy Pro

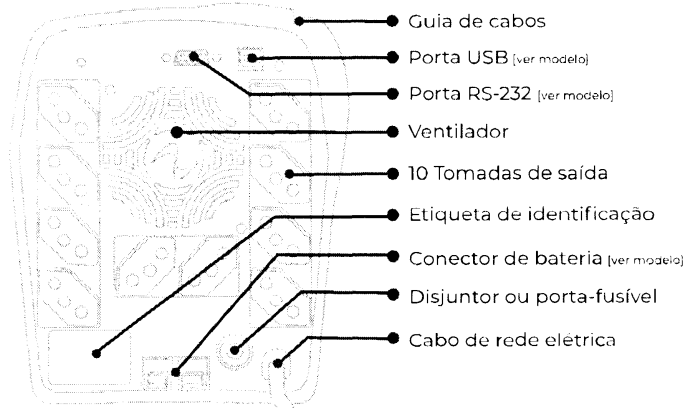

O painel traseiro poderá variar de acordo com o modelo

Troca fácil de bateria

simples substituição da bateria pelo usuário

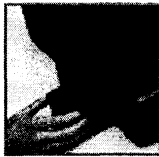

Software de gerenciamento

Supervise Personal (download gratuito)

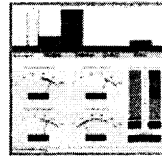

Painel Easy Pro

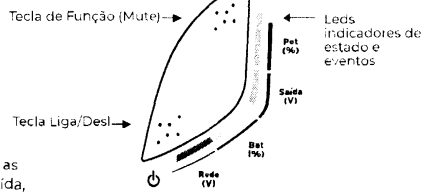

Através de um simples toque no botão é possível visualizar nos LEDs e no Display as informações de tensão de entrada, de saída, de potência instalada e de nível de baterias. É possível também visualizar eventos críticos e ocorrências tais como o envelhecimento das baterias, erros de operação, etc.

Signalização sonora em todos os eventos e falhas com tecla de silenciamento (mute).

Características técnicas da linha Easy Pro

potência nominal [VA]*	1400	1600	2000	3200
fator de potência	0,7			
faixa de regulação em modo rede	89V até 260V [Ti] / 174V até 260V [M2]			
faixa de operação em modo rede	80V até 266V [Ti] / 166V até 266V [M2]			
rendimento	> 95% com rede e > 85% com inversor			
regulação de saída do inversor	< +/- 2% - com carga linear			
tempo de acionamento do inversor	0,8 ms			
tempo de carga da bateria interna [até 80%]	8 horas			
forma de onda do inversor	senoidal pura			
frequência de saída do inversor [+/-1%]	60Hz			
tempo de resposta do estabilizador	1 ciclo de rede			
regulação em modo rede [atende NBR 14373]	-6%/ +6%[Ti] -4%/ +4% [M2]			
powerlook - battery save [auto-desligamento]	sim [modelos com USB]			
proteção eletrônica contra sobrecarga	Sim			
proteção contra surtos de tensão varistor 65J [8x20 μs]	Sim			
número de tomadas	10			
peso líquido [kg]	12,5	13,8	15,7	15,7
peso bruto [kg]	12,8	14,1	16,0	16,0
dimensões do equipamento A x L x P [mm]	215 x 170 x 485			
dimensões da embalagem A x L x P [mm]	285 x 180 x 495			

[*Aplicação em equipamentos de informática]

Tempo de autonomia			módulos externos de baterias + baterias internas		
aplicações típicas	modelos recomendados	2 baterias seladas internas	mini-módulo de bateria MMB24V	um módulo a automotivo MBI24V	dois módulos automotivos MBI24V
15"	EP1400/EP1600 EP2000/EP3200	65 min 80 min	3 h 45 min 3 h 50 min	5 h 43 min 5 h 48 min	12 h 12 h 05 min
17"	3X EP1400/EP1600 EP2000/EP3200	14 min 20 min	47 min 52 min	1 h 43 min 1 h 48 min	3 h 38 min 3 h 43 min
19"	4X EP2000/EP3200	08 min	20 min	1 h 8 min	2 h 22 min
21"	5X EP2000/EP3200	-	14 min	44 min	1 h 36 min
23"	8X EP2000/EP3200	-	08 min	26 min	56 min

legenda: Micro on board Micro off board ink jet

verifique a potência máxima permitida [FP-070]

Outras aplicações:



Obs: verifique a potência máxima permitida no manual. Não acompanha módulos de baterias. O tempo de autonomia poderá variar em função do envelhecimento das baterias, temperatura de operação, bem como das características do micro conectado.

Recursos comparativos de modelos	Vio	CBu	USB	NET*	STD*
Conector de engate para módulos de bateria	Sim	Sim	Não	Não	Não
Porta USB	Sim	Sim	Sim	Não	Não
Porta RS-232	Sim	Não	Não	Não	Não
Baterias Internas	Sim	Sim	Sim	Sim	Sim
True Full Range, seleção automática [modelos Ti]	Sim	Sim	Sim	Sim	Sim
Proteção telefônica com dois plugs RJ-11	Não	Não	Não	Sim	Não

[*modelos NET e STD somente sob encomenda]

Configurações	trivolt [Ti]	monovolt* 220V [M2]
tensão de entrada	automática [full range]	220V
tensão de saída	115V	220V

[*somente sob encomenda]



Abalencas



TOSHIBA

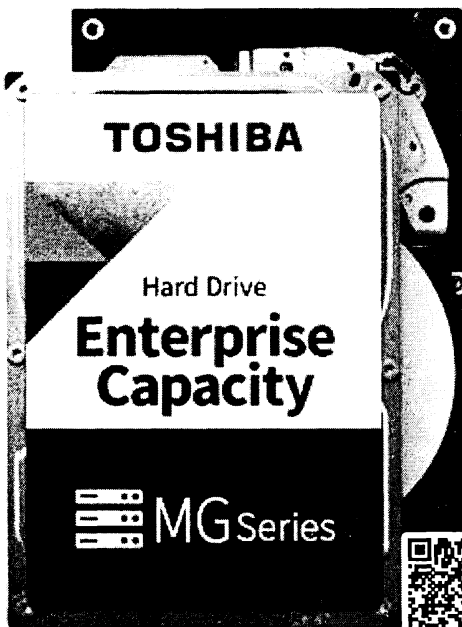

View more

MG Series Enterprise Capacity Hard Drives

As Big Data drives demand for more distributed storage in the cloud and on premises, enterprise server and storage systems need to be built using trusted solutions. Toshiba's Enterprise Capacity Hard Drive – MG Series offers formatted capacities as high as 22 TB with interface options including SATA and SAS and delivers 24/7 operation at a workload of 550 TB/year. The MG Series is ideal for enterprise storage array and industrial server and storage systems. It provides the capacity and advanced technologies to meet the special demands of datacenter and cloud-scale infrastructures.

Use for

- Enterprise Server
- Enterprise Storage
- Cloud Scale up and Scale out Storage
- Archive Systems
- Industrial and Surveillance Storage

Top Features

- 3.5" SATA or SAS Hard Drive
- 7,200 rpm
- Persistent Write Cache Technology
- 550 TB/year workload
- Flexibility in block size
- 24/7 operation
- 5-year warranty

Capacities

22 TB	20 TB	18 TB	16 TB	14 TB	12 TB
10 TB	8 TB	6 TB	4 TB	2 TB	1 TB



Handwritten notes and signatures:
 M.G.
 [Signature]
 [Signature]
 [Signature]

MG Series

 Enterprise Hard Drives

Model Number	Specification					Performance		Reliability				
	Fill Gas & Recording	Capacity (GB)	Block Size (Byte)	Buffer Size (MiByte)	Interface	Security Options	Data Rate (sustained) (MB/s)	Operating Power (W) typ.	MTTF (hrs)	Unrecoverable Error Rate		
Enterprise Capacity HDD with SAS 12 Gbit/s Interface – Business Critical Storages with large capacity												
MG04SCA20EN	Air CMR	2,000	512n	128	SAS	SIE	204	11.8	1.4 mill.	1 in 10 ¹⁵		
MG08SDA400N		4,000		256	12 Gbit/s	SIE/SED	233	8.5	2.0 mill.			
MG04SCA20EE		2,000	512e	128	SAS 12 Gbit/s	SIE	215	11.8	1.4 mill.	1 in 10 ¹⁵		
MG08SDA400E		4,000		256		SIE/SED	255	8.5	2.0 mill.			
MG08SDA600E		6,000		SIE/SED		251	9.2	2.0 mill.				
MG08SDA800E		8,000		SIE/SED		260	9.9	2.0 mill.				
MG06SCA10TE		10,000		256		SIE/SED	249	11.0	2.5 mill.			
MG07SCA12TE		12,000		SIE/SED		254	7.8					
MG07SCA14TE		14,000	512	SIE/SED	260	8.4	2.5 mill.					
MG08SCA16TE		16,000			SIE/SED	275		8.2				
MG09SCA18TE	18,000	Helium MAMR	512	SIE/SED	281	9.2	2.5 mill.					
MG10SCA20TE	20,000			SIE/SED	281	9.6						
MG10SFA22TE	22,000			SIE/SED	284	10.2						
MG04SCA20EA	Air CMR	2,000	4Kn	128	SAS 12 Gbit/s	SIE	215	11.8	1.4 mill.	1 in 10 ¹⁵		
MG08SDA400A		4,000		256		SIE/SED	255	8.5	2.0 mill.			
MG08SDA600A		6,000	4Kn	256	SAS 12 Gbit/s	SIE/SED	251	9.2	2.0 mill.	1 in 10 ¹⁵		
MG08SDA800A		8,000				SIE/SED	260	9.9	2.0 mill.			
MG06SCA10TA		10,000				SIE/SED	249	11.0	2.5 mill.			
MG07SCA12TA		12,000				SIE/SED	254	7.8				
MG07SCA14TA		14,000				Helium CMR	512	SIE/SED	260		8.4	2.5 mill.
MG08SCA16TA		16,000						SIE/SED	275		8.2	
MG09SCA18TA		18,000	Helium MAMR	512	SIE/SED	281	9.2	2.5 mill.				
MG10SCA20TA		20,000			SIE/SED	281	9.6					
Enterprise Capacity HDD with SATA 6 Gbit/s Interface – Mainstream Server and Storage, Hyperscale- and Cloud Storage												
MG04ACA100N	Air CMR	1,000	512n	128	SATA	SIE	204	11.3	1.4 mill.	1 in 10 ¹⁵		
MG04ACA200N		2,000		256	6 Gbit/s	SIE	204	11.3	1.4 mill.			
MG08ADA400N		4,000	512e	256	SATA 6 Gbit/s	SIE/SED	233	8.1	2.0 mill.	1 in 10 ¹⁵		
MG04ACA200E		2,000				128	SIE	184	11.3		1.4 mill.	
MG08ADA400E		4,000				256	SIE/SED	255	8.1		2.0 mill.	
MG08ADA600E		6,000				SIE/SED	251	8.7	2.0 mill.			
MG08ADA800E		8,000				SIE/SED	260	9.5	2.0 mill.			
MG06ACA10TE		10,000				256	SIE/SED	249	10.6		2.5 mill.	
MG07ACA12TE		12,000	SIE/SED	254	7.8							
MG07ACA14TE		14,000	Helium CMR	512	SIE/SED	260	8.0	2.5 mill.				
MG08ACA16TE	16,000	SIE/SED			275	7.7						
MG09ACA18TE	18,000	Helium MAMR	512	SIE/SED	281	9.3	2.5 mill.					
MG10ACA20TE	20,000			SIE/SED	281	9.3						
MG10AFA22TE	22,000			SIE/SED	284	9.8						
MG04ACA200A	Air CMR	2,000	4Kn	128	SATA 6 Gbit/s	SIE	184	11.3	1.4 mill.	1 in 10 ¹⁵		
MG08ADA400A		4,000		256		SIE/SED	255	8.1	2.0 mill.			
MG08ADA600A		6,000	4Kn	256	SATA 6 Gbit/s	SIE/SED	251	8.7	2.0 mill.	1 in 10 ¹⁵		
MG08ADA800A		8,000				SIE/SED	260	9.5	2.0 mill.			
MG06ACA10TA		10,000				256	SIE	249	10.6		2.5 mill.	
MG07ACA12TA		12,000				SIE	254	7.8				
MG07ACA14TA		14,000				Helium CMR	512	SIE	260		8.0	2.5 mill.
MG08ACA16TA		16,000						SIE/SED	275		7.7	
MG09ACA18TA		18,000	Helium MAMR	512	SIE/SED	281	8.3	2.5 mill.				
MG10ACA20TA		20,000			SIE/SED	281	9.3					

Handwritten signatures and initials:
 - Top right: JH
 - Middle right: B
 - Bottom right: K
 - Bottom center: A

Nome do Produto	Descrição			
-----------------	-----------	--	--	--

SDC SERVER MONO

1x GABINETE 2U, 6 BAIAS 3,5"; 2 BAIAS INTERNA FIXA

1x FONTE SINGLE 550W PFC ATIVO ATX

1x PLACA MÃE SERVER, 2 PORTAS DE REDE
1GbE, CHIPSET INTEL

1x PROCESSADOR INTEL XEON E-2378G
(8C 16T/2.80GHZ)

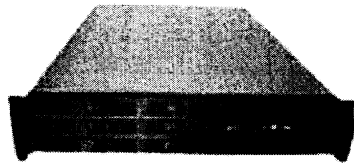

2x MEMORIA 32GB DDR4 ECC UDIMM

1x SSD SATA 240GB 2.5"

4x HD 10TB SATA 3,5" SURVEILLANCE

1x CONTROLADORA RAID 0,1,5,6,10,50,60 SUPORTA
ATÉ 16 HDDS

1x SISTEMA OPERACIONAL WINDOWS 10 PRO

Handwritten signature and scribbles.

Handwritten mark.

Handwritten signature.

Handwritten mark.

Nome do Produto

Descrição

SDC SERVER WKS

1x GABINETE PADRAO TORE

1x FONTE SINGLE 550W PFC ATIVO ATX

1x PLACA MÃE, 1 PORTA DE REDE 1GbE, CHIPSET INTEL

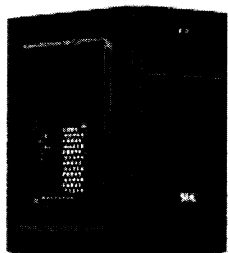

1x PROCESSADOR INTEL CORE I5-12400 (6C/12T 2.5G)

1x MEMORIA 16GB DDR4 UDIMM

1x SSD 512GB M.2 NVME

1x HD 2TB SATA 3,5" SURVEILLANCE

1x KIT TECLADO E MOUSE USB PRETO BÁSICO ABNT2

1x SISTEMA OPERACIONAL WINDOWS 10 PRO

Nome do Produto	Descrição			
-----------------	-----------	--	--	--

SDC SERVER WKS

1x GABINETE PADRAO TORRE

1x FONTE SINGLE 650W PFC ATIVO ATX

1x PROCESSADOR INTEL CORE I7-12700 (12C/20T 2.1G)

1x MEMORIA 16GB DDR4 UDIMM

1x SSD 512GB M.2 NVME

1x HD 2TB SATA 3,5" SURVEILLANCE

1x KIT TECLADO E MOUSE USB PRETO BÁSICO ABNT2

1x SISTEMA OPERACIONAL WINDOWS 10 PRO

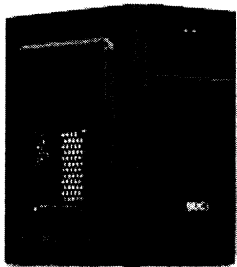

[Handwritten signature]

[Handwritten mark]

[Handwritten mark]

[Handwritten mark]

[Handwritten mark]

[Handwritten signature]

DATASHEET MONITOR 22" FULL HD

Cor	Preto
Altura do produto	39,6 centímetros
Largura do produto	48,8 centímetros
Tamanho de tela vertical	22 Polegadas
Resolução	1920 x 1080 Pixels
Tecnologia de conexão	D-Sub, HDMI
Número de Conexões HDMI	1
Voltagem	110 Volts, 220 Volts
Tecnologia do sintonizador	Digital
Fonte de alimentação	AC
Pilhas ou baterias inclusas	Não
Peso do produto	2,3 Kilograms
Dimensões do produto	23,2 x 48,8 x 39,6 cm; 2,3 Quilogramas

[Handwritten mark]

[Handwritten signatures and marks]

DATASHEET MONITOR MONITOR LED 23" FULL HD

CONECTIVIDADE	
HDMI	Sim
VGA	Sim
Display Port	Não
ESPECIFICAÇÕES TÉCNICAS	
Cor	Preto
Taxa de Hz	100 Hz Full HD
Furação Vesa	75x75mm
Suporte/Base	De fácil montagem (com slide)
TELA	
Polegadas	23.8 POL Super fina
Resolução	1.920 x 1.080 Full HD
Ângulo de visão	178° Horizontal 178° Vertical
Quantidade de Cores	16.7 milhões
Tempo de resposta	5 ms
Ângulo de Inclinação	-5° 15°
Contraste	4000:01:00
Antirreflexo	Possui
Filtro de Luz Azul	Possui
Caixa de som	Não Possui
FreeSync	Possui
Brilho (Max)	250cd/m2
SRGB	-99%
ALIMENTAÇÃO	
Bivolt	
Baixo consumo no modo stanby, 0,5w	
DIMENSÃO DO MONITOR	
Altura (cm)	32
Largura (cm)	54
Profundidade (cm)	4
Peso (kg)	2,21
DIMENSÃO COM BASE	
Altura (cm)	40
Largura (cm)	54
Profundidade (cm)	17,5
Peso (kg)	2,444

(Handwritten signature)

(Handwritten signature)

(Handwritten signature)

(Handwritten mark)

④

2000000

10

1000000

1000000

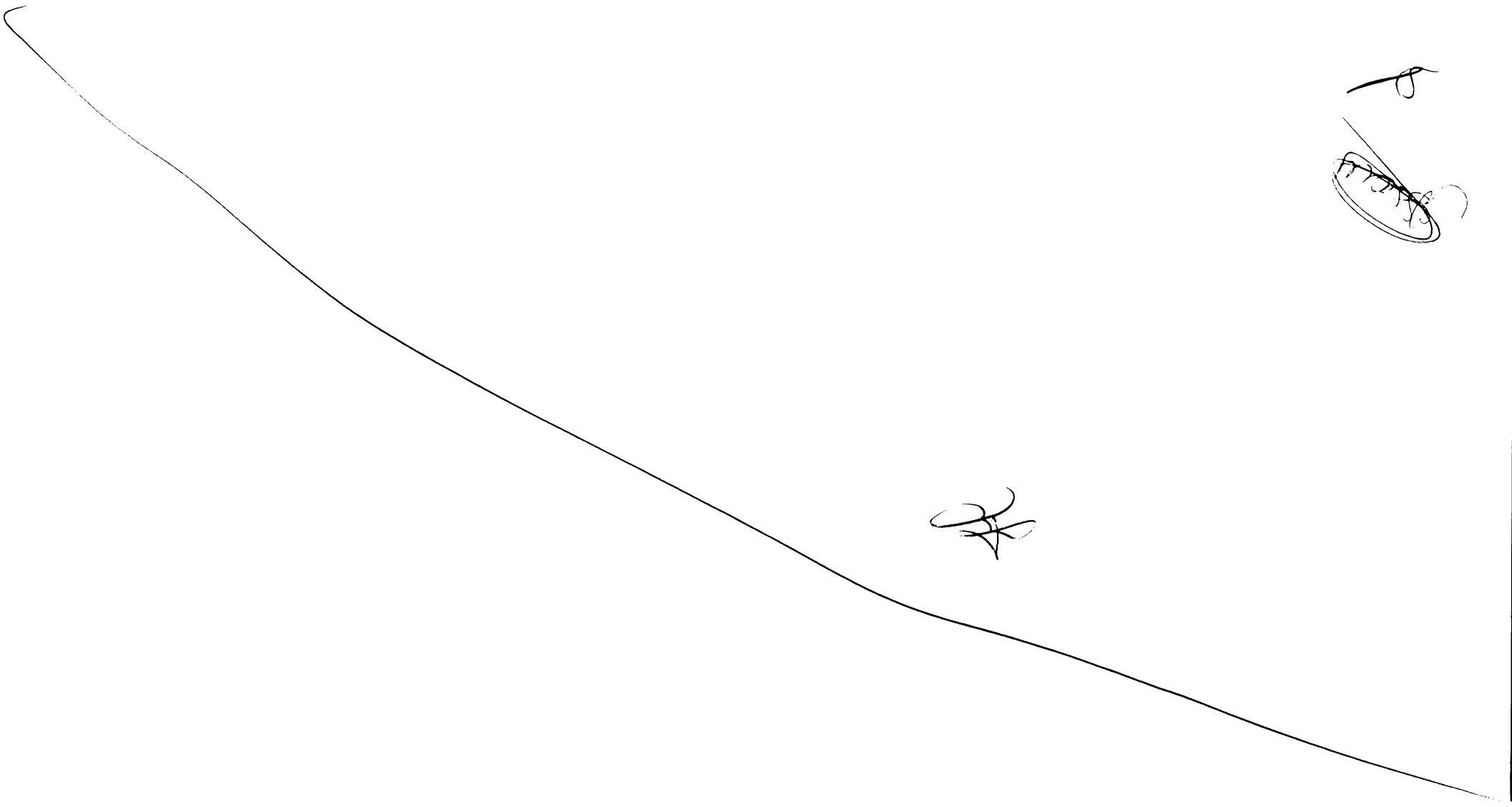

DATASHEET TV 40" LCD FULL HD

Sistema Operacional	Android
Interface do hardware	Bluetooth, USB, HDMI
Resolução	1080p (1920 x 1080 Pixels)
Características especiais	Plana
Peças para montagem	1 Controle Remoto RC802V, 1 Cabo Adaptador P2/RCA, 2 Pilhas AAA, 2 Bases, 1 Cabo de Alimentação sem pino terra, 4 Parafusos \varnothing 4x25mm Para fixar as bases ao televisor (Pedestal),
Tecnologia da tela	LED
Tamanho da tela	40 Polegadas
Proporção da tela	16:9
Resolução máxima	16 Pixels
Etiqueta Nacional de Eficiência Energética (ENCE)	1
Potência em watts	20 watts
Tipo de fonte de energia	Energia elétrica
Baterias inclusas	Não
Funciona com baterias	Não
Frequência	60 Hz
Taxa de atualização	60 Hz
Total de entradas USB	1
Tecnologia de conexão	Bluetooth, Wi-fi, USB, HDMI
Inclui controle remoto	Sim
Bluetooth	Sim
Cor	Preta
Cor correspondente	Preta
Conexões	USB Bluetooth
Distância focal máxima	USB, HDMI
Garantia do fabricante	1 ano com o fabricante
Peso do produto	6,5 Kilograms
Dimensões do produto	7,6 x 90,2 x 52 cm; 6,5 Quilogramas

H

